

Bandpass Filter 251054B



1. Features

- IF bandpass filter
- Single-ended operation
- Ceramic Surface Mount Device(SMD) Package
- Maximum Storage Temperature Range : -40℃ ~ 85℃
- Electrostatics Sensitive Device (ESD)

2. Package Dimension

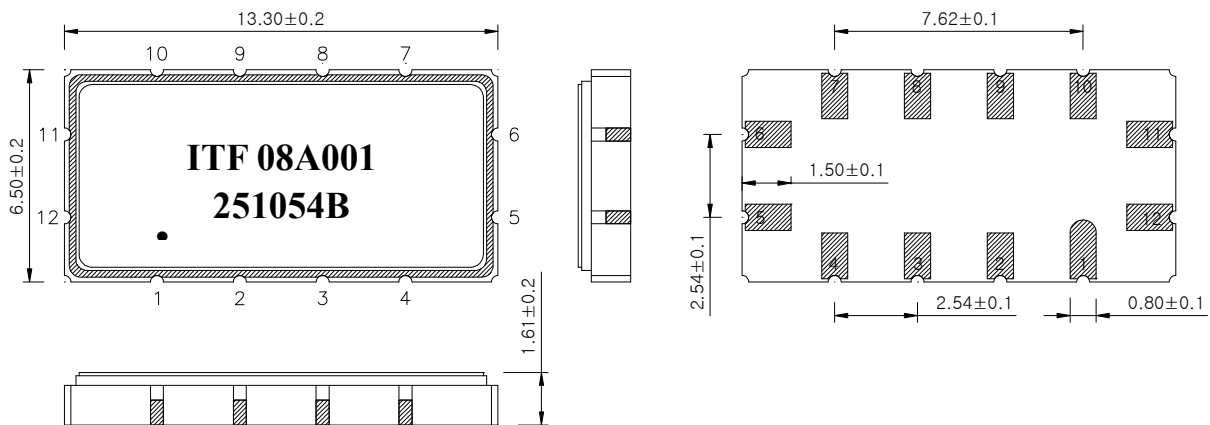

Package : S1365

Dimensions shown are nominal in millimeters

Body : Al₂O₃

Lid : Kovar, Ni Plated

Termination : Au plating 0.3 ~ 1.0um, over a 1.27 ~ 8.89um Ni Plating

Pin Configuration	
11	Input
5	Output
6, 12	Ground
Other	Case ground

	ITF Co., Ltd. 102-901, Bucheon Technopark 364, Samjeong-Dong, Ojeong-Gu, Bucheon-City, Gyeonggi-Do, Korea 421-809	Part No.	251054B	
		Rev. Date	2008-05-30	
		Rev.	NW8011-CS01	1/5

Bandpass Filter 251054B



3. Specifications

F_o = 125.0 MHz

Terminating source impedance : 50Ω and matching network

Terminating load impedance : 50Ω and matching network

Room temperature range : +25°C		Minimum	Typical	Maximum
Center Frequency (F _c)	MHz	-	125.0	-
Insertion Loss	dB	-	21.0	24.0
1dB Bandwidth	MHz	8.6	9.3	-
3dB Bandwidth	MHz	-	10.0	-
40dB Bandwidth	MHz	-	13.2	15.0
Amplitude Ripple (F _o +/- 3.8 MHz)	dB	-	0.3	0.9
Group Delay Variation (F _o +/-3.8 MHz)	nsec	-	25	60
Absolute Delay	usec	-	0.82	-
Ultimate Rejection	dB	45	50	-
Temperature Coefficient of Frequency (TCF)	ppm/°C	-	-18	-

Notes :

- 1) All specifications are based on the matching schematic shown below
- 2) All specifications are measured by Agilent Network analyzer and full 2 port calibration
- 3) All attenuation measurements are measured relative to insertion loss

	ITF Co., Ltd. 102-901, Bucheon Technopark 364, Samjeong-Dong, Ojeong-Gu, Bucheon-City, Gyeonggi-Do, Korea 421-809	Part No.	251054B	
		Rev. Date	2008-05-30	
		Rev.	NW8011-CS01	2/5

Bandpass Filter 251054B



4. Matching Schematic

(Actual matching values may vary due to PCB layout and parasitics)

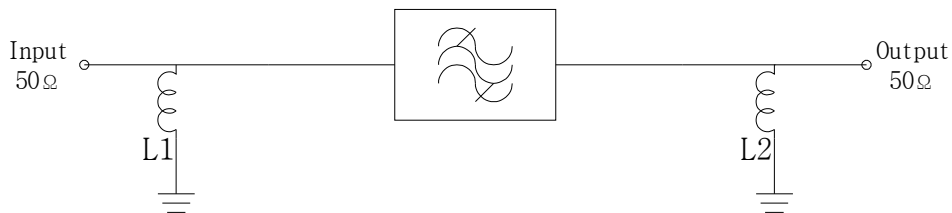

L1 = 33 nH , L2 = 56 nH

5. Marking Configuration

ITF¹⁾08A001²⁾
251054B³⁾



- 1) Manufacturer name
- 2) Lot Number
- 3) Part Number
- 4) Pad Number 1 Index

	ITF Co., Ltd. 102-901, Bucheon Technopark 364, Samjeong-Dong, Ojeong-Gu, Bucheon-City, Gyeonggi-Do, Korea 421-809	Part No.	251054B	
		Rev. Date	2008-05-30	
		Rev.	NW8011-CS01	3/5

Bandpass Filter 251054B



6. Typical Performance (at +25°C)

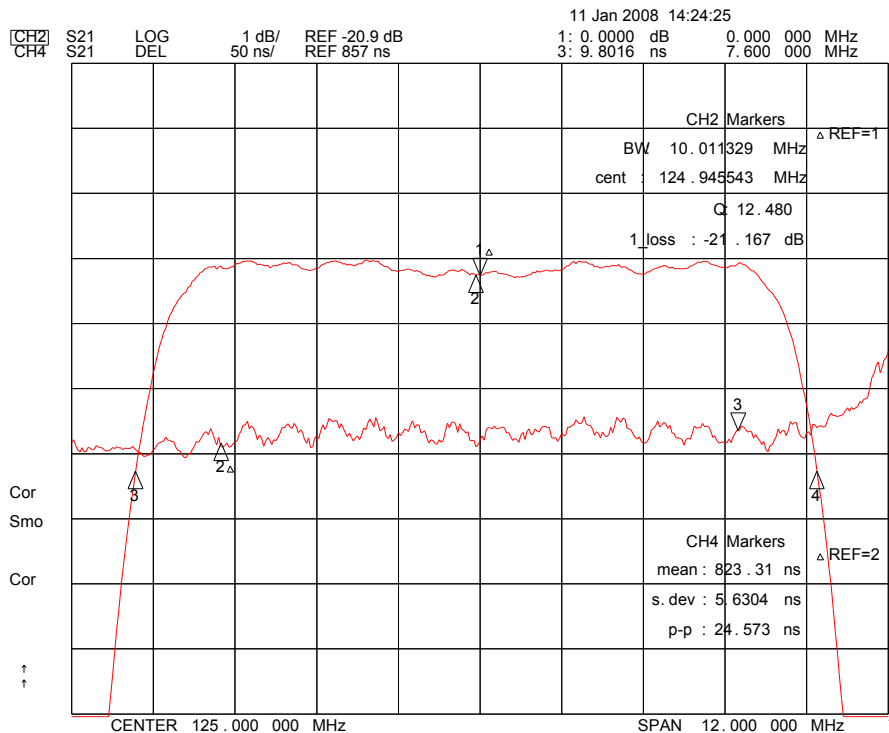
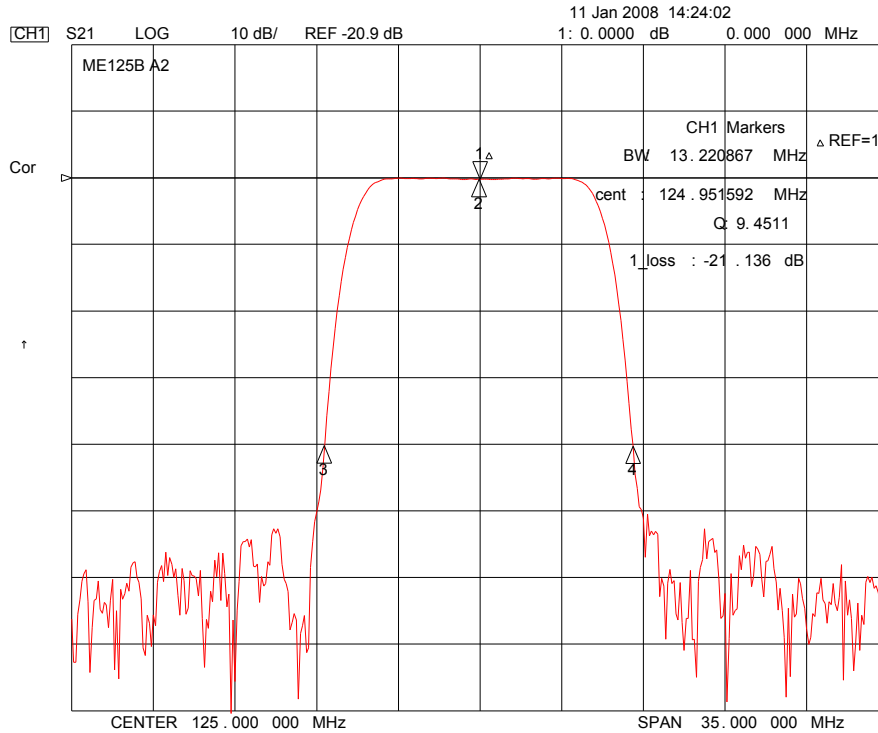

	ITF Co., Ltd. 102-901, Bucheon Technopark 364, Samjeong-Dong, Ojeong-Gu, Bucheon-City, Gyeonggi-Do, Korea 421-809	Part No.	251054B	
		Rev. Date	2008-05-30	
		Rev.	NW8011-CS01	4/5

Bandpass Filter 251054B

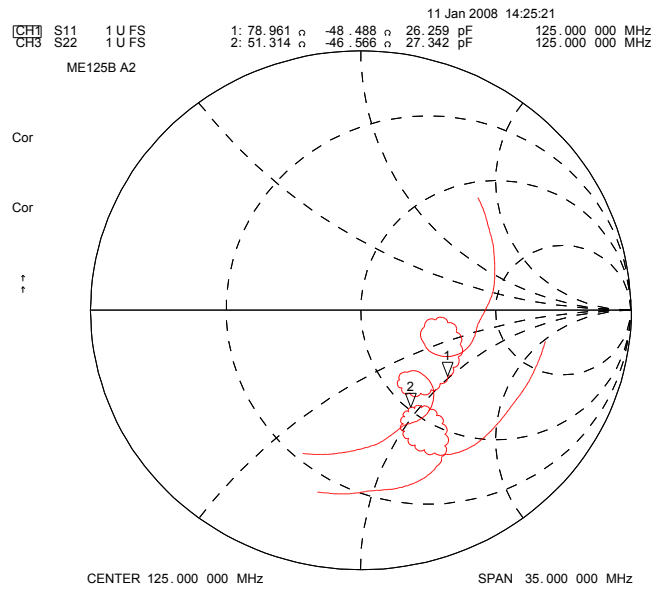
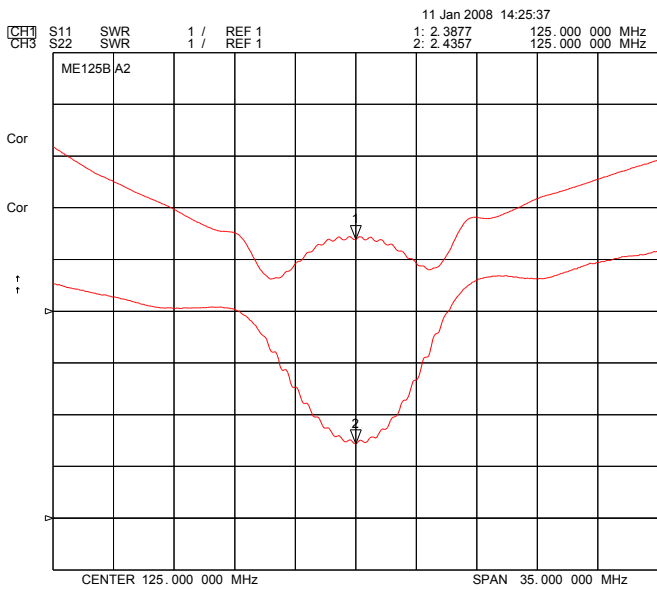
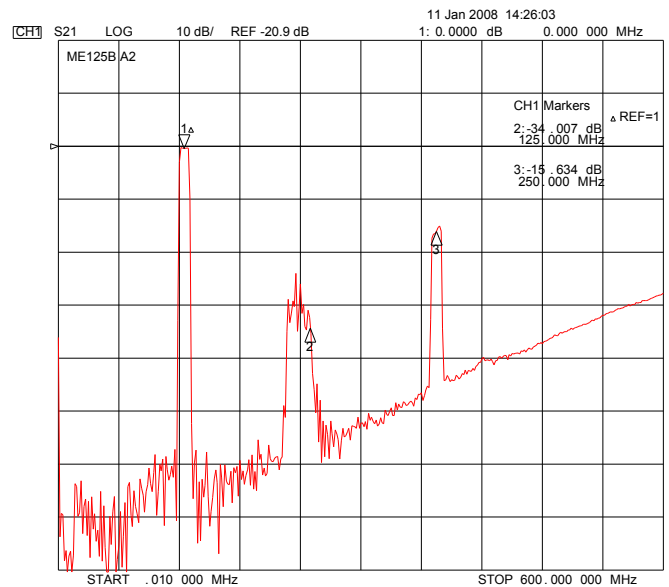
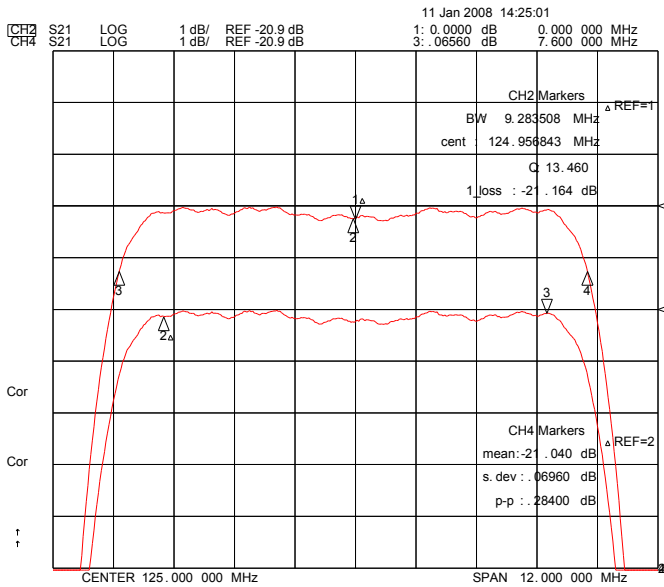

ITF Co., Ltd.
 102-901, Bucheon Technopark 364,
 Samjeong-Dong, Ojeong-Gu, Bucheon-City,
 Gyeonggi-Do, Korea 421-809

Part No.	251054B	
Rev. Date	2008-05-30	
Rev.	NW8011-CS01	5/5