

Bandpass Filter 270251B



1. Features

- IF bandpass filter
- Low-Loss Filter
- Single-ended operation
- Ceramic Surface Mount Device(SMD) Package
- Maximum Storage Temperature Range : -40℃ ~ 85℃
- Electrostatics Sensitive Device (ESD)

2. Package Dimension

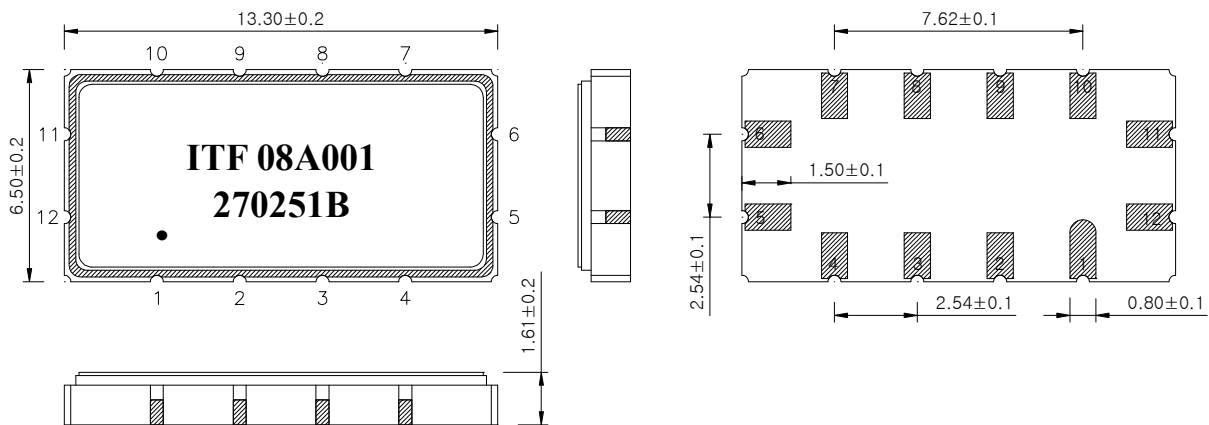

Package : S1365

Dimensions shown are nominal in millimeters

Body : Al₂O₃

Lid : Kovar, Ni Plated

Termination : Au plating 0.3 ~ 1.0um, over a 1.27 ~ 8.89um Ni Plating

Pin Configuration	
11	Input
5	Output
6, 12	Ground
Other	Case ground

	ITF Co., Ltd. 102-901, Bucheon Technopark 364, Samjeong-Dong, Ojeong-Gu, Bucheon-City, Gyeonggi-Do, Korea 421-809	Part No.	270251B	
		Rev. Date	2008-05-16	
		Rev.	NJ8007-AS01	1/5

Bandpass Filter 270251B



3. Specifications

Fo = 70.0 MHz

Terminating source impedance : 50Ω and matching network

Terminating load impedance : 50Ω and matching network

Operating temperature range : -40℃ ~ +85℃		Minimum	Typical	Maximum
Center Frequency (Fc)	MHz	-	70.0	-
Insertion Loss	dB	-	7.0	10.0
1dB Bandwidth	MHz	1.6	2.1	-
3dB Bandwidth	MHz	-	2.73	-
40dB Bandwidth	MHz	-	4.9	5.5
Amplitude Ripple (Fo +/- 0.4 MHz)	dB	-	0.7	1.0
Group Delay Variation (Fo +/- 0.4 MHz)	nsec	-	80	150
Absolute Delay	usec	-	1.23	-
Ultimate Rejection	dB	40	45	-
Temperature Coefficient of Frequency (TCF)	ppm/°C	-	- 86	-

Room temperature : + 25 ℃		Minimum	Typical	Maximum
Insertion Loss	dB	-	7.0	9.5
Amplitude Ripple (Fo +/- 0.8 MHz)	dB	-	0.7	1.0
Group Delay Variation (Fo +/- 0.8 MHz)	nsec	-	80	150

Notes :

- 1) All specifications are based on the matching schematic shown below
- 2) All specifications are measured by Agilent Network analyzer and full 2 port calibration
- 3) Electrical margin has been built into the design to account for the variations due to temperature drift and manufacturing tolerances
- 4) All attenuation measurements are measured relative to insertion loss

	ITF Co., Ltd. 102-901, Bucheon Technopark 364, Samjeong-Dong, Ojeong-Gu, Bucheon-City, Gyeonggi-Do, Korea 421-809	Part No.	270251B	
		Rev. Date	2008-05-16	
		Rev.	NJ8007-AS01	2/5

Bandpass Filter 270251B



4. Matching Schematic

(Actual matching values may vary due to PCB layout and parasitics)

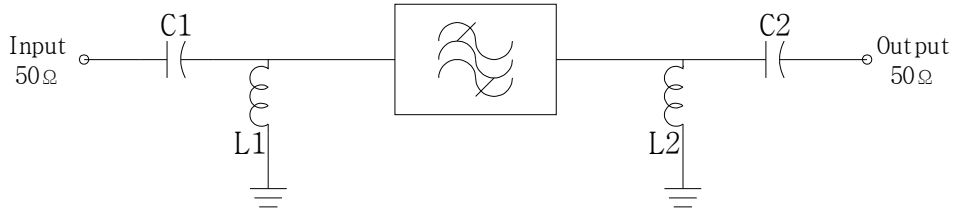

$$C1 = C2 = 56 \text{ pF}$$

$$L1 = 120 \text{ nH}, \quad L2 = 82 \text{ nH}$$

5. Marking Configuration

ITF¹⁾ 08A001²⁾

270251B³⁾

●⁴⁾

1) Manufacturer name

2) Lot Number

3) Part Number

4) Pad Number 1 Index

 Integrated Technology Future	ITF Co., Ltd. 102-901, Bucheon Technopark 364, Samjeong-Dong, Ojeong-Gu, Bucheon-City, Gyeonggi-Do, Korea 421-809	Part No.	270251B	
		Rev. Date	2008-05-16	
		Rev.	NJ8007-AS01	3/5

Bandpass Filter 270251B



6. Typical Performance (at +25°C)

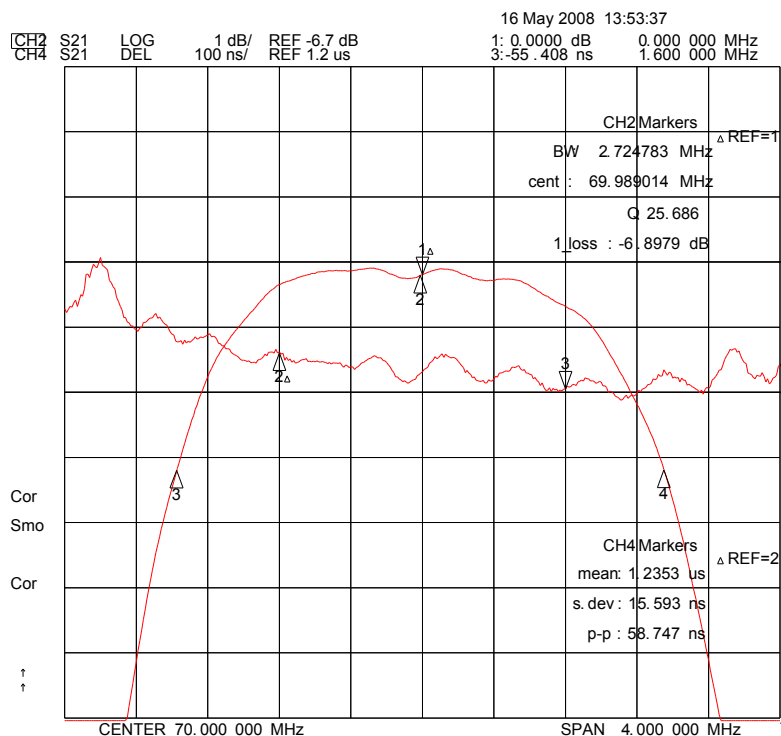
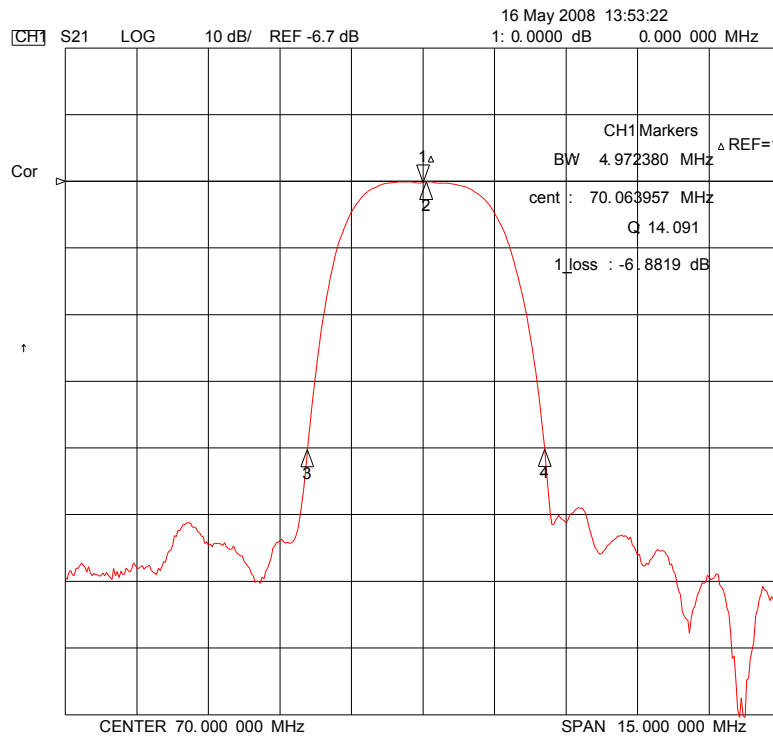

ITF Co., Ltd.
 102-901, Bucheon Technopark 364,
 Samjeong-Dong, Ojeong-Gu, Bucheon-City,
 Gyeonggi-Do, Korea 421-809

Part No.	270251B	
Rev. Date	2008-05-16	
Rev.	NJ8007-AS01	4/5

Bandpass Filter 270251B

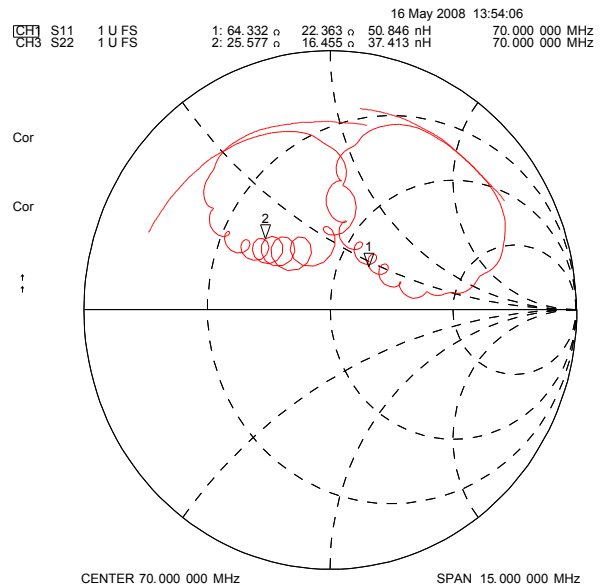
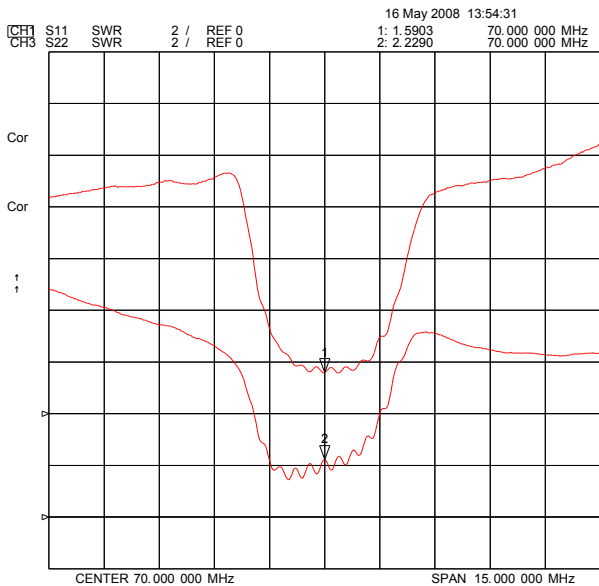
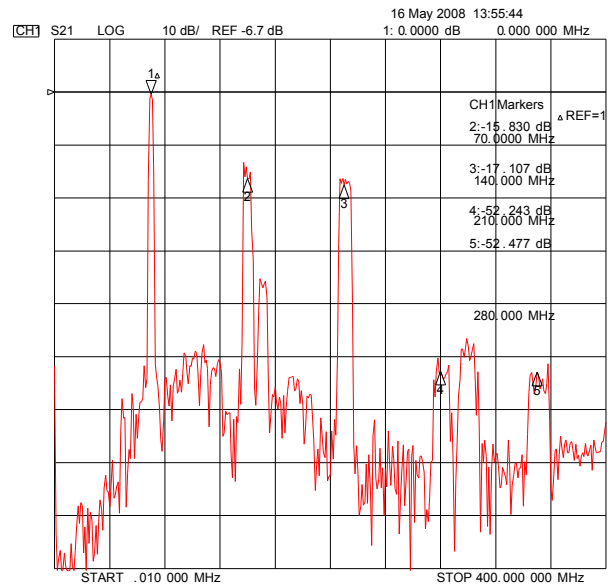
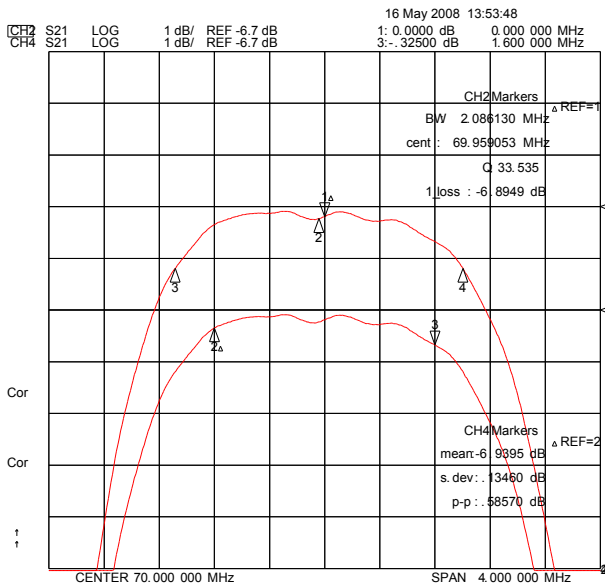

ITF Co., Ltd.
 102-901, Bucheon Technopark 364,
 Samjeong-Dong, Ojeong-Gu, Bucheon-City,
 Gyeonggi-Do, Korea 421-809

Part No.	270251B	
Rev. Date	2008-05-16	
Rev.	NJ8007-AS01	5/5