

# SAW Resonator R40351



## Features

- 1-port Resonator
- Quartz Frequency Stabilization
- For transmitters or Local Oscillators

## Package Dimension – S5050

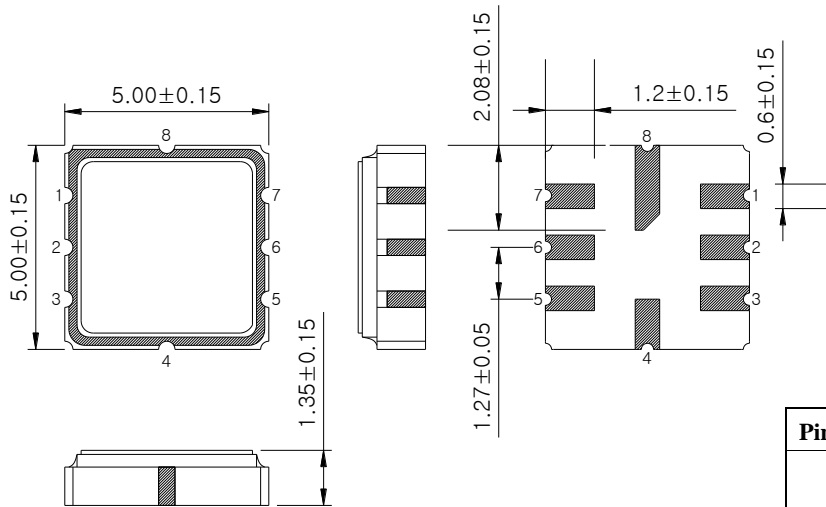

Pin Configuration	
2	Input
6	Output
1, 3, 4, 5, 7, 8	Ground

## Marking Configuration

ITF<sup>1)</sup>  
40351<sup>2)</sup>

1) Manufacturer name

2) Marking Number

\* Ink or Laser Marking available

\* Front 4 digits for S5050

	<b>ITF Co., Ltd.</b> 102-901, Bucheon Technopark 364, Samjeong-Dong, Ojeong-Gu, Bucheon-City, Gyeonggi-Do, Korea 421-809	Part No.	R40351	
		Rev. Date	2015-10-30	
		Rev.	NS3117-AS02	1/5

# SAW Resonator R40351



## Maximum Ratings

Parameter	Unit	Minimum	Typical	Maximum
Operating Temperature Range	°C	-10	25	60
Storage Temperature Range	°C	-40	-	85
Power Handling Capability	dBm	-	0	-

Electrostatics Sensitive Device (ESD)

## Electrical Specification

$F_R = 403.550\text{MHz}$

Terminating source impedance :  $50\Omega$  and matching network

Terminating load impedance :  $50\Omega$  and matching network

		Minimum	Typical	Maximum
Resonance Frequency ( $F_R$ )	MHz	403.475	403.550	403.625
Insertion Loss	dB	-	1.5	2.5
50 ohm Loaded Q Unloaded Q			2,000 12,800	
Trun-over Temperature	°C	10	25	40
Temperature Coefficient of Frequency	ppm/°C <sup>2</sup>	-	-0.032	-

### Notes :

- 1) All specifications are based on the matching schematic shown below
- 2) All specifications are measured by Agilent Network analyzer and full 2 port calibration at room temperature

	<b>ITF Co., Ltd.</b> 102-901, Bucheon Technopark 364, Samjeong-Dong, Ojeong-Gu, Bucheon-City, Gyeonggi-Do, Korea 421-809	Part No.	R40351	
		Rev. Date	2015-10-30	
		Rev.	NS3117-AS02	2/5

# SAW Resonator R40351



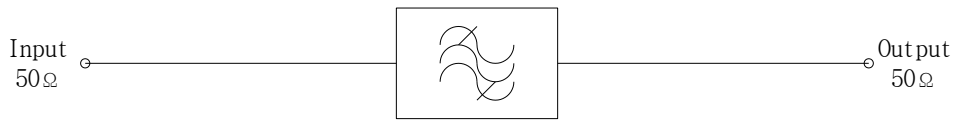

## Matching Schematic

( Actual matching values may vary due to PCB layout and parasitics )

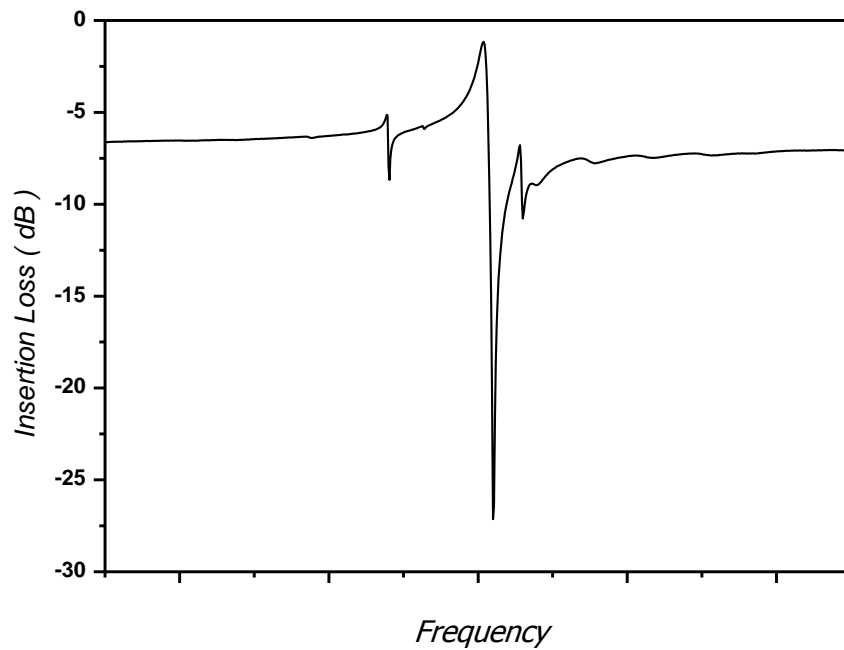

## Frequency Response



 Integrated Technology Future	<b>ITF Co., Ltd.</b> 102-901, Bucheon Technopark 364, Samjeong-Dong, Ojeong-Gu, Bucheon-City, Gyeonggi-Do, Korea 421-809	Part No.	R40351	
		Rev. Date	2015-10-30	
		Rev.	NS3117-AS02	3/5

# SAW Resonator R40351



## Packing Specification

1. Reeling Quantity : 1000 pcs / reel
2. Taping Structure : The tape shall be wound around the reel in the direction shown below.

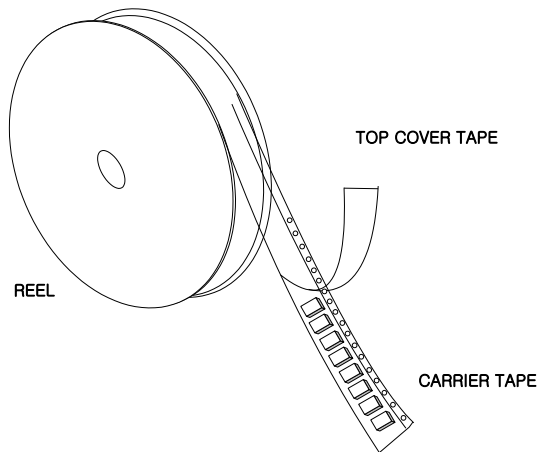

## Tape Specification

1. Leader part and vacant position specification

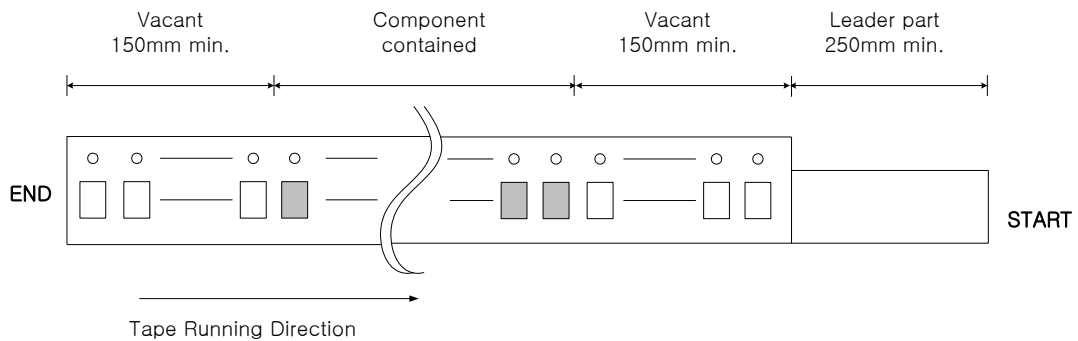



2. Tensile strength of carrier tape

4.4N/mm width

3. Top cover tape adhesion

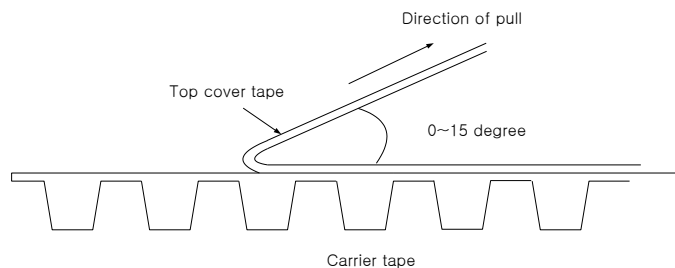
- 1) pull off angle : 0~15°
- 2) speed : 300mm/min
- 3) force : 20~70g



 Integrated Technology Future	<b>ITF Co., Ltd.</b> 102-901, Bucheon Technopark 364, Samjeong-Dong, Ojeong-Gu, Bucheon-City, Gyeonggi-Do, Korea 421-809	Part No.	R40351	
		Rev. Date	2015-10-30	
		Rev.	NS3117-AS02	4/5

# SAW Resonator R40351



## Carrier Tape Dimensions [unit : mm]

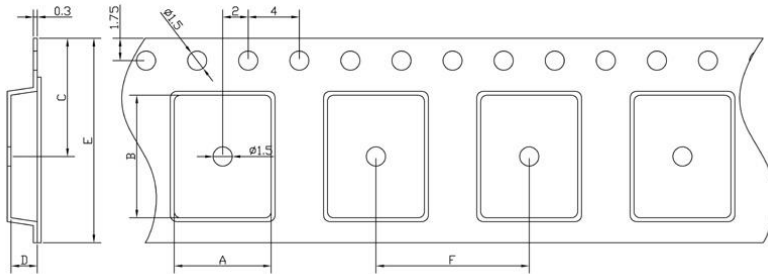

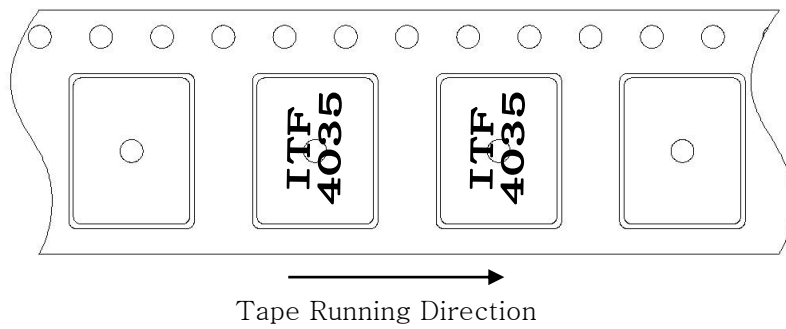

A	5.50 ± 0.1
B	5.50 ± 0.1
C	7.25 ± 0.1
D	1.95 ± 0.1
E	12.00 ± 0.1
F	8.00 ± 0.1

## Part Direction

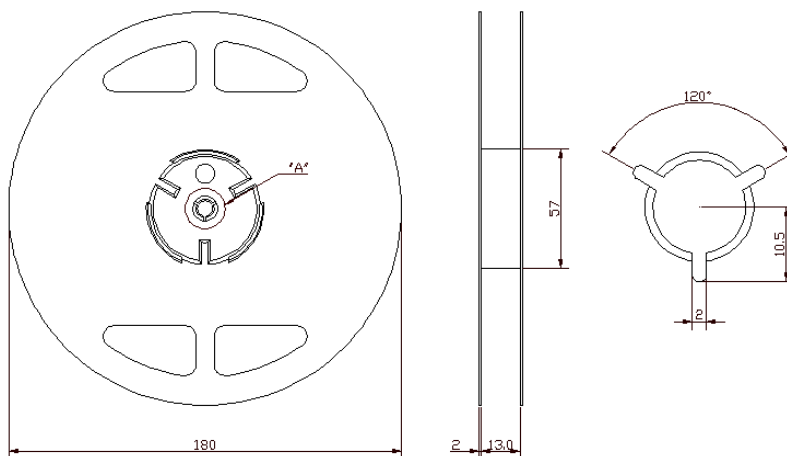

## Reel Dimensions [unit : mm]



 Integrated Technology Future	<b>ITF Co., Ltd.</b> 102-901, Bucheon Technopark 364, Samjeong-Dong, Ojeong-Gu, Bucheon-City, Gyeonggi-Do, Korea 421-809	Part No.	R40351	
		Rev. Date	2015-10-30	
		Rev.	NS3117-AS02	5/5