

SAW Bandpass Filter F3253



Features

- RF bandpass filter
- Usable bandwidth 4.0 MHz
- No matching 50Ω single-ended operation
- Ceramic Surface Mounted Device (SMD) Package (5.0mm * 5.0mm)
- RoHS Compliant

Package Dimensions

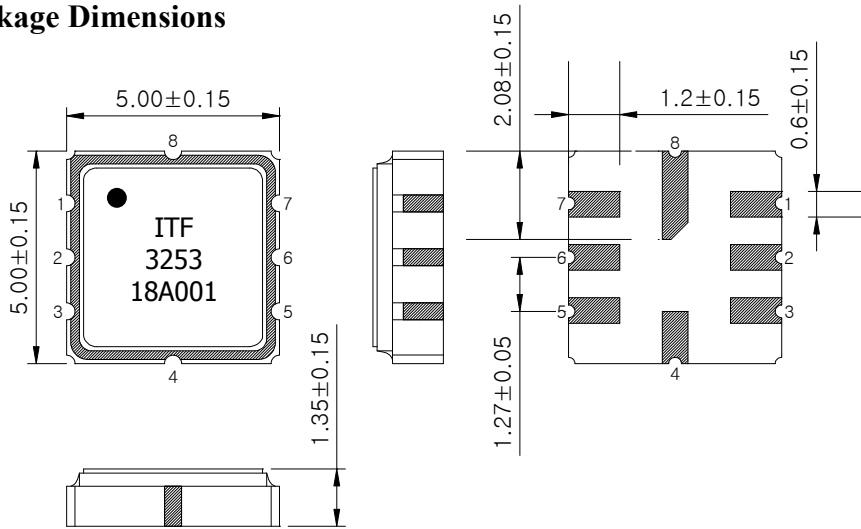

Dimensions shown are nominal in millimeters

Body : Al_2O_3 Ceramic

Lid : Kovar, Ni Plated

Terminations : Au plating 0.3 ~ 1.0 μm , Over a 1.27 ~ 8.89 μm Ni Plating

Pin Configuration	
2	Input
6	Output
1, 3, 4, 5, 7, 8	Ground

Maximum Ratings

Parameter	Unit	Minimum	Typical	Maximum
Operating Temperature Range	°C	-40	25	80
Storage Temperature Range	°C	-40	-	85
Power Handling Capability	dBm	-	-	10

Electrostatics Sensitive Device (ESD)

	ITF Co., Ltd. 102-901, Bucheon Technopark 364, Samjeong-Dong, Ojeong-Gu, Bucheon-City, Gyeonggi-Do, Korea 421-809	Part No.	F3253	
		Rev. Date	2018-06-21	
		Rev.	NRTF03-AS02	1/7

SAW Bandpass Filter F3253



Specifications

Fc = 325.0 MHz

		Minimum	Typical	Maximum
Center Frequency (Fc)	MHz	-	325	-
Insertion Loss (Fc ± 2.0 MHz)	dB	-	2.0	3.5
Amplitude Ripple (Fc ± 2.0 MHz)	dB	-	0.6	1.5
VSWR (Fc ± 2.0 MHz)		-	1.5	2.0
Absolute Attenuation				
225.0 ~ 305.0 MHz	dB	35	45	-
350.0 ~ 425.0 MHz		35	50	-

Notes :

- 1) All specifications are based on the matching schematic shown below, measured by Agilent Network analyzer and full 2 port calibration.
- 2) Electrical margin has been built into the design to account for the variations due to temperature drift and manufacturing tolerances

 Integrated Technology Future	ITF Co., Ltd. 102-901, Bucheon Technopark 364, Samjeong-Dong, Ojeong-Gu, Bucheon-City, Gyeonggi-Do, Korea 421-809	Part No.	F3253	
		Rev. Date	2018-06-21	
		Rev.	NRTF03-AS02	2/7

SAW Bandpass Filter F3253



Matching Schematic

(Actual matching values may vary due to PCB layout and parasitics)

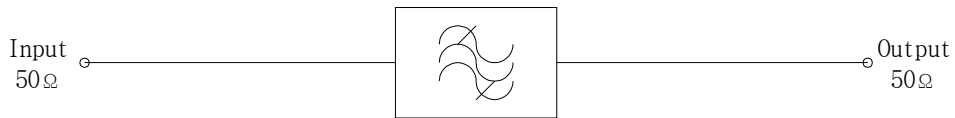

Marking Configuration

- ¹⁾
ITF ²⁾
3253 ³⁾
18A001 ⁴⁾

1) Pad Number 1 Index

2) Manufacturer name

3) Marking Number

4) Lot Number

* Ink or Laser Marking available

 Integrated Technology Future	ITF Co., Ltd. 102-901, Bucheon Technopark 364, Samjeong-Dong, Ojeong-Gu, Bucheon-City, Gyeonggi-Do, Korea 421-809	Part No.	F3253	
		Rev. Date	2018-06-21	
		Rev.	NRTF03-AS02	3/7

SAW Bandpass Filter F3253



Typical Performance (at 25°C)

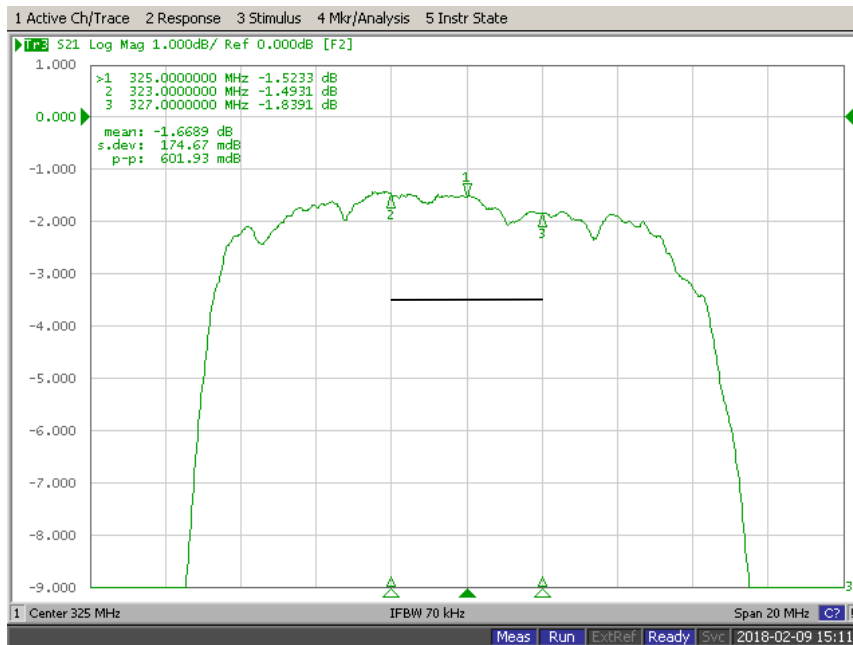
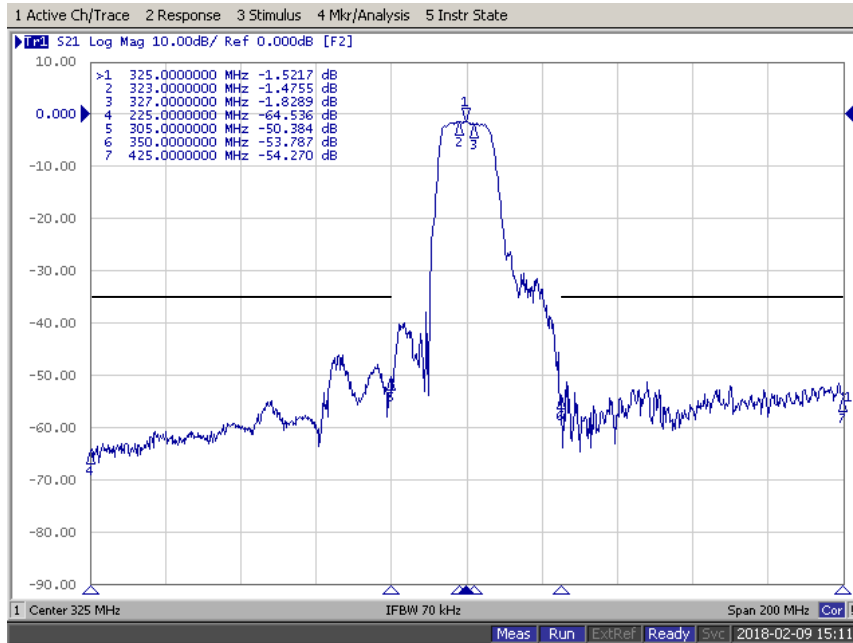

ITF Co., Ltd.
102-901, Bucheon Technopark 364,
Samjeong-Dong, Ojeong-Gu, Bucheon-City,
Gyeonggi-Do, Korea 421-809

Part No.	F3253	
Rev. Date	2018-06-21	
Rev.	NRTF03-AS02	4/7

SAW Bandpass Filter F3253



Input / Output VSWR Charts

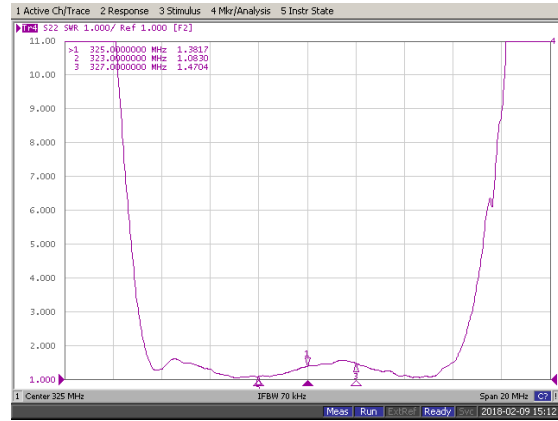
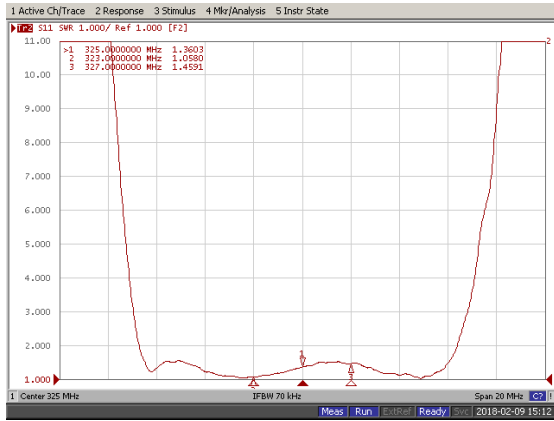

Input / Output Smith Charts

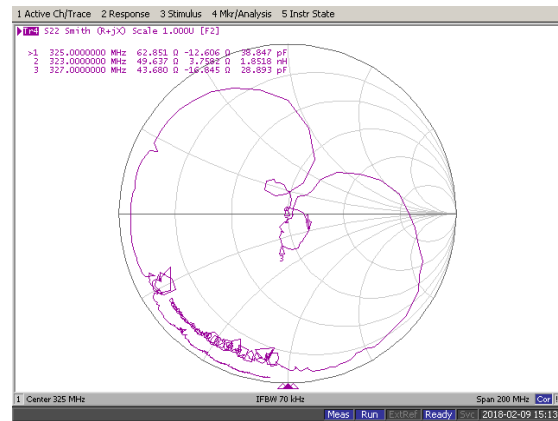
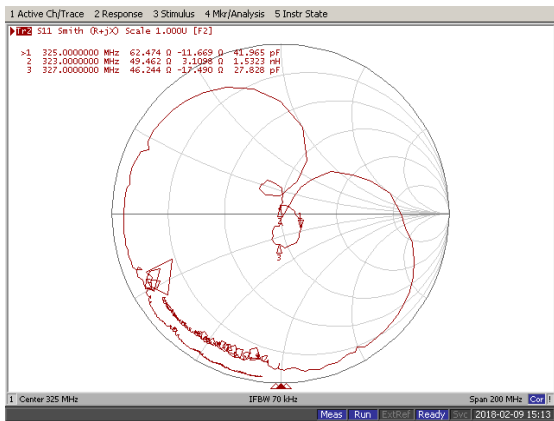

ITF Co., Ltd.
 102-901, Bucheon Technopark 364,
 Samjeong-Dong, Ojeong-Gu, Bucheon-City,
 Gyeonggi-Do, Korea 421-809

Part No.	F3253	
Rev. Date	2018-06-21	
Rev.	NRTF03-AS02	5/7

SAW Bandpass Filter F3253



Packing Specification

1. Reeling Quantity : 1000 pcs / reel
2. Taping Structure : The tape shall be wound around the reel in the direction shown below.

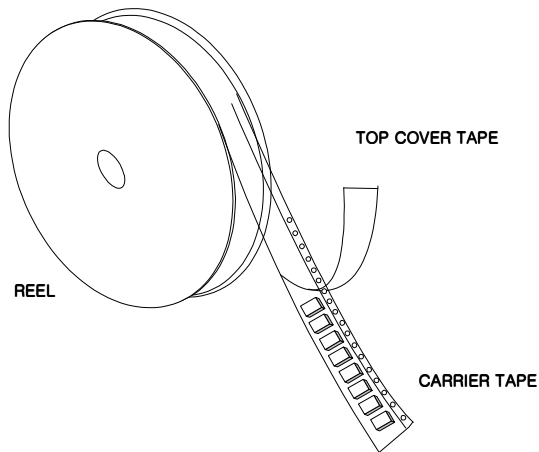

Tape Specification

1. Leader part and vacant position specification

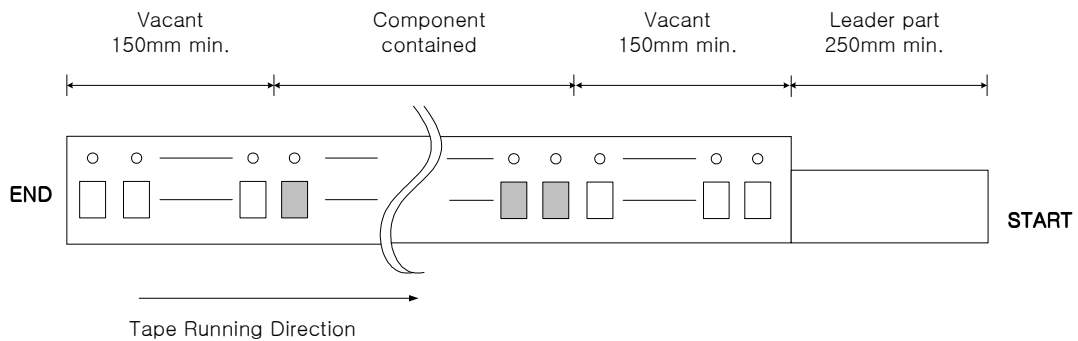

2. Tensile strength of carrier tape

4.4N/mm width

3. Top cover tape adhesion

- 1) pull off angle : 0~15°
- 2) speed : 300mm/min
- 3) force : 20~70g

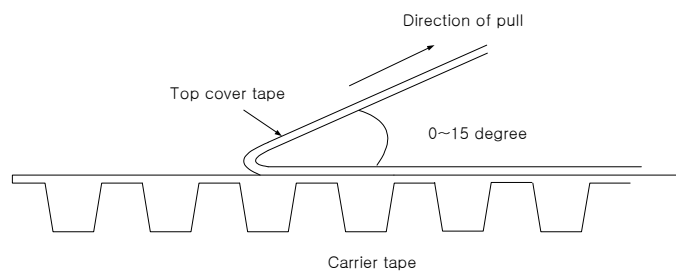

	ITF Co., Ltd. 102-901, Bucheon Technopark 364, Samjeong-Dong, Ojeong-Gu, Bucheon-City, Gyeonggi-Do, Korea 421-809	Part No.	F3253	
		Rev. Date	2018-06-21	
		Rev.	NRTF03-AS02	6/7

SAW Bandpass Filter F3253



Carrier Tape Dimensions [unit : mm]

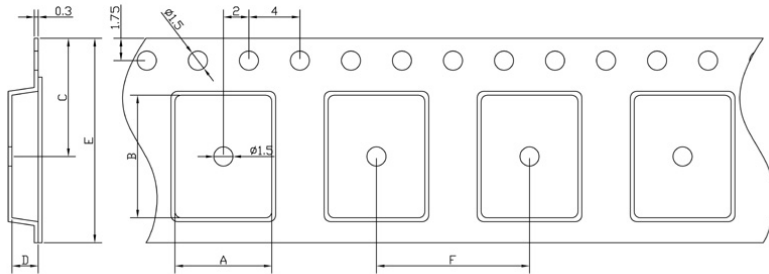

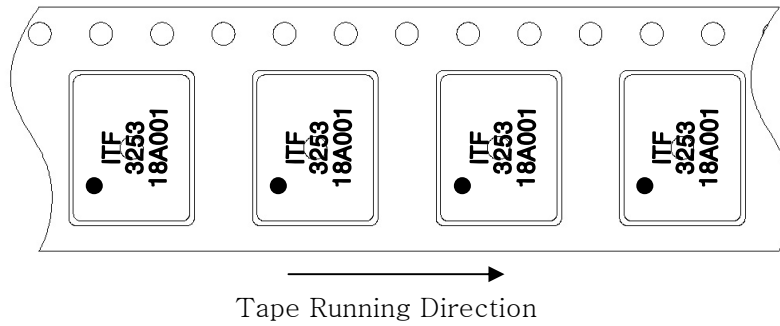

A	5.50 ± 0.1
B	5.50 ± 0.1
C	7.25 ± 0.1
D	1.95 ± 0.1
E	12.00 ± 0.1
F	8.00 ± 0.1

Part Direction

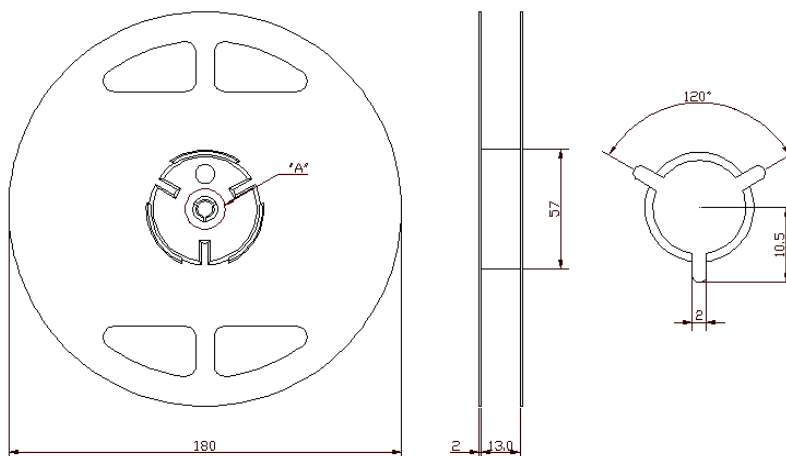

Reel Dimensions [unit : mm]



	ITF Co., Ltd. 102-901, Bucheon Technopark 364, Samjeong-Dong, Ojeong-Gu, Bucheon-City, Gyeonggi-Do, Korea 421-809	Part No.	F3253	
		Rev. Date	2018-06-21	
		Rev.	NRTF03-AS02	7/7