

SAW Bandpass Filter F4521



Features

- RF bandpass filter for CDMA450 C-Band Tx. Part
- Usable bandwidth 5MHz (450 MHz ~ 455 MHz)
- High attenuation
- No matching 50Ω single-ended operation
- Ceramic Surface Mounted Device Package (3.8 mm × 3.8 mm)
- RoHS compliant

Package Dimensions

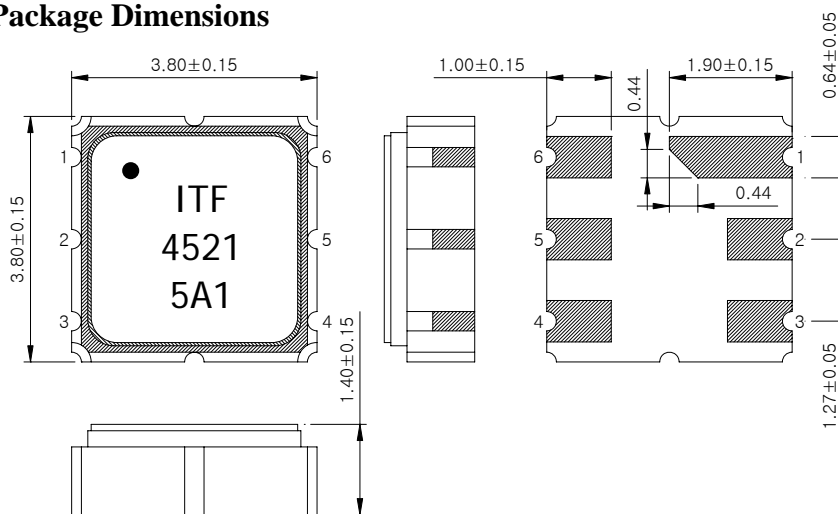

Dimensions shown are nominal in millimeters

Body : Al₂O₃ Ceramic

Lid : Kovar, Ni Plated

Terminations : Au plating 0.3 ~ 1.0 um, Over a 1.27 ~ 8.89 um
Ni Plating

Pin Configurations

2	Input
5	Output
1, 3, 4, 6	Case ground

Maximum Ratings

Parameters	Unit	Minimum	Typical	Maximum
Operating Temperature Range	°C	-30	25	85
Storage Temperature Range	°C	-40	-	85
Power Handling Capability	dBm	-	-	30

Electrostatics Sensitive Device (ESD)

	ITF Co., Ltd. 102-901, Bucheon Technopark 364, Samjeong-Dong, Ojeong-Gu, Bucheon-City, Gyeonggi-Do, Korea 421-809	Part No.	F4521	
		Rev. Date	2006-06-08	
		Rev.	NR3016-AS02	1/7

SAW Bandpass Filter F4521



Specifications

	Minimum	Typical	Maximum	Unit
Center Frequency (Fc)	-	452.5	-	MHz
Insertion Loss (In Fc +/- 2.5 MHz)	-	2.0	2.8	dB
Amplitude Ripple (In Fc +/- 2.5 MHz)	-	0.8	1.2	dB
VSWR (In Fc +/- 2.5 MHz)	-	1.5	2.0	
Relative Attenuation				
0.3 MHz ~ 347.5 MHz	30	35	-	dB
347.5 MHz ~ 441.5 MHz	25	30	-	
460.0 MHz ~ 465.0 MHz	35	43	-	
465.0 MHz ~ 1700 MHz	27	32	-	
1700 MHz ~ 2000 MHz	20	25	-	
Temperature Range (Operational)	-30	25	85	°C
Input RF Power (In Fc +/- 2.5 MHz)			30	dBm
Input/Output Impedance		50		Ohms

Notes :

- 1) All specifications are based on the matching schematic shown below, measured by Agilent Network analyzer and full 2 port calibration.
- 2) Electrical margin has been built into the design to account for the variations due to temperature drift and manufacturing tolerances
- 3) All attenuation measurements are measured relative to insertion loss

 Integrated Technology Future	ITF Co., Ltd. 102-901, Bucheon Technopark 364, Samjeong-Dong, Ojeong-Gu, Bucheon-City, Gyeonggi-Do, Korea 421-809	Part No.	F4521	
		Rev. Date	2006-06-08	
		Rev.	NR3016-AS02	2/7

SAW Bandpass Filter F4521



Matching Schematic

(Actual matching values may vary due to PCB layout and parasitics)

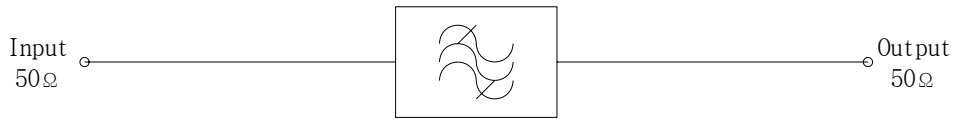

Marking Configuration

- ¹⁾
ITF²⁾
4521³⁾
5A1⁴⁾

- 1) Pad Number 1 Index
- 2) Manufacturer name
- 3) Marking Number
- 4) Lot Number

* Ink or Laser Marking available

 Integrated Technology Future	ITF Co., Ltd. 102-901, Bucheon Technopark 364, Samjeong-Dong, Ojeong-Gu, Bucheon-City, Gyeonggi-Do, Korea 421-809	Part No.	F4521	
		Rev. Date	2006-06-08	
		Rev.	NR3016-AS02	3/7

SAW Bandpass Filter F4521



Typical Performance (at 25 °C)

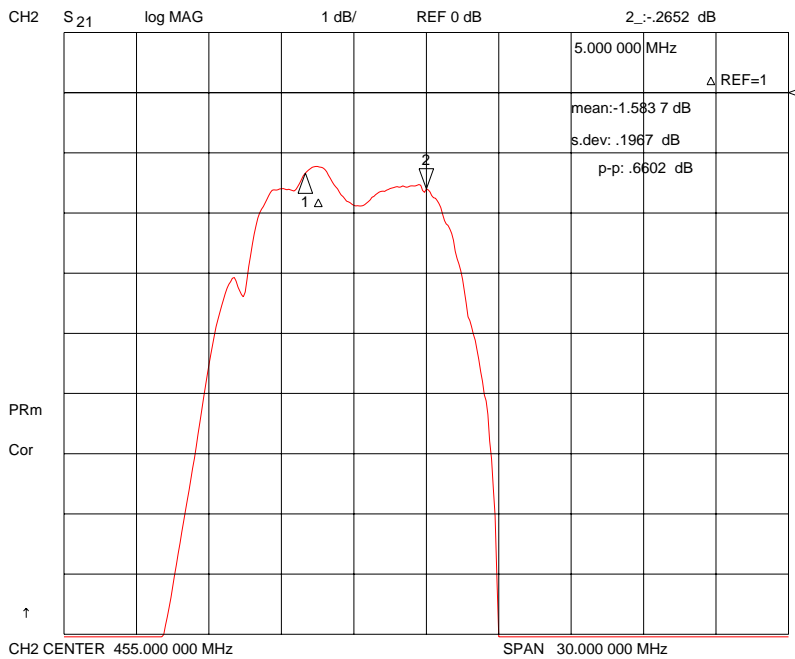
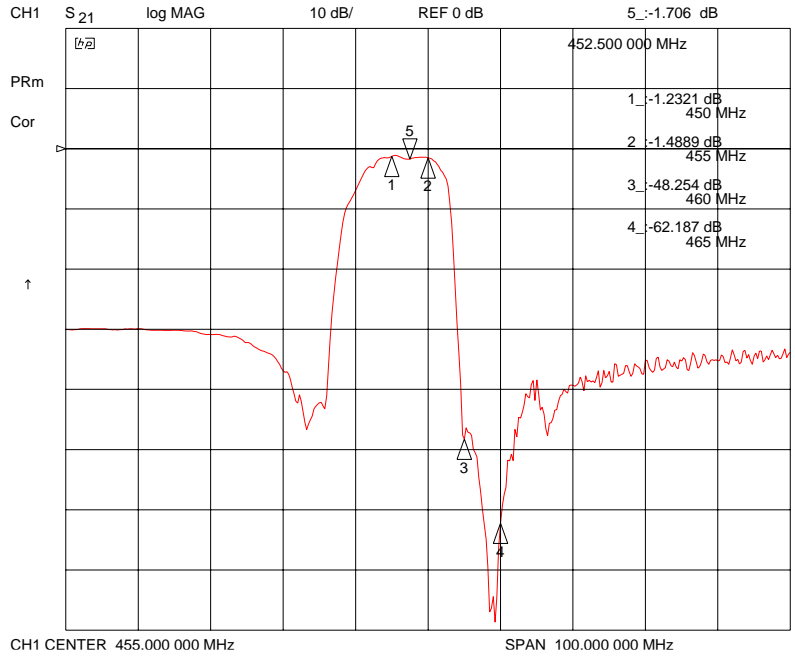

	ITF Co., Ltd. 102-901, Bucheon Technopark 364, Samjeong-Dong, Ojeong-Gu, Bucheon-City, Gyeonggi-Do, Korea 421-809	Part No.	F4521	
		Rev. Date	2006-06-08	
		Rev.	NR3016-AS02	4/7

SAW Bandpass Filter F4521



Input / Output VSWR Charts

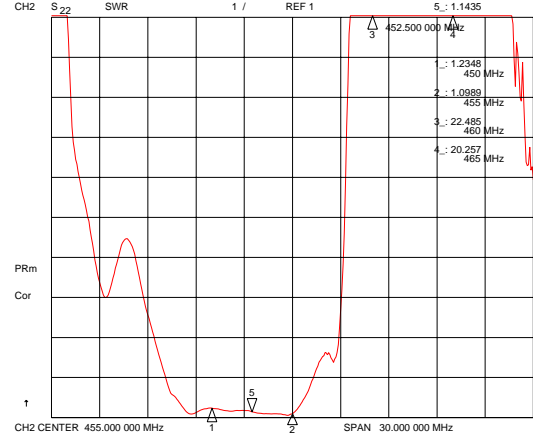
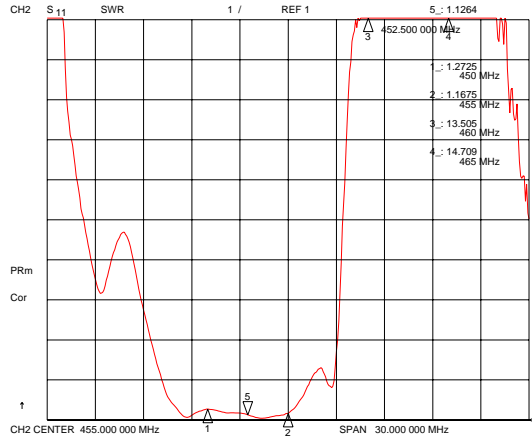

Input / Output Smith Charts

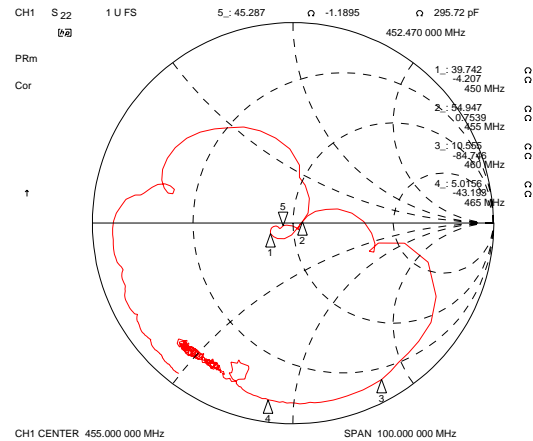
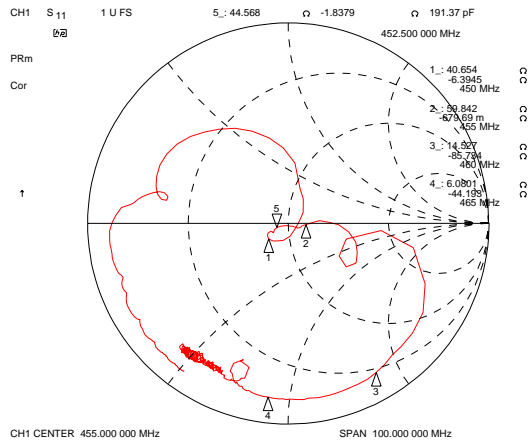

	ITF Co., Ltd. 102-901, Bucheon Technopark 364, Samjeong-Dong, Ojeong-Gu, Bucheon-City, Gyeonggi-Do, Korea 421-809	Part No.	F4521	
		Rev. Date	2006-06-08	
		Rev.	NR3016-AS02	5/7

Packing Specification

1. Reeling Quantity : 3000 pcs / 13" reel (or 1000 pcs / 7" reel)
2. Taping Structure : The tape shall be wound around the reel in the direction shown below.

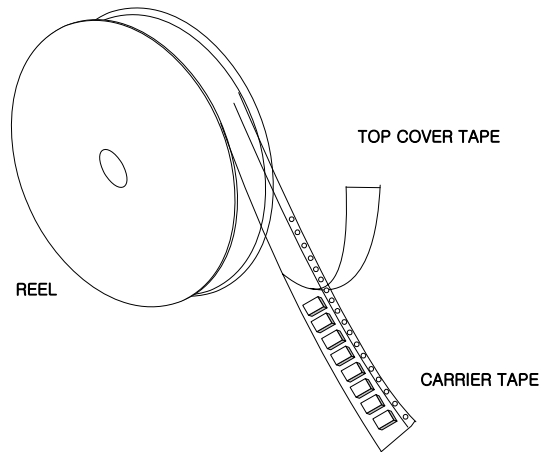

Tape Specification

1. Leader part and vacant position specification

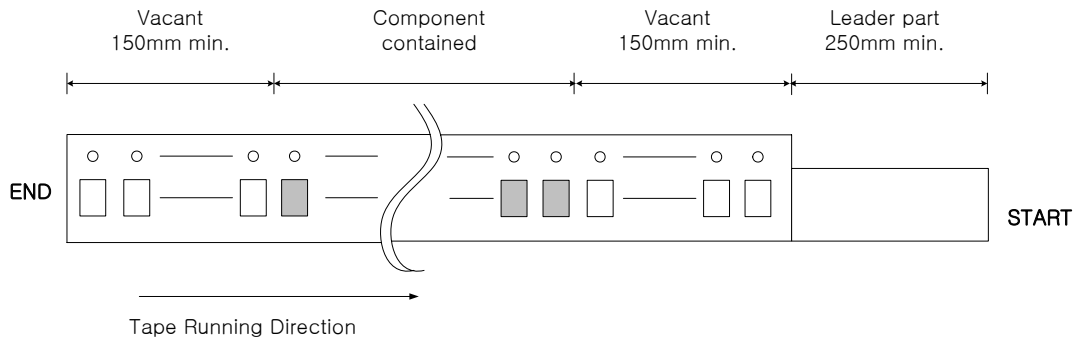

2. Tensile strength of carrier tape

4.4N/mm width

3. Top cover tape adhesion

- 1) pull off angle : 0~15°
- 2) speed : 300mm/min
- 3) force : 20~70g

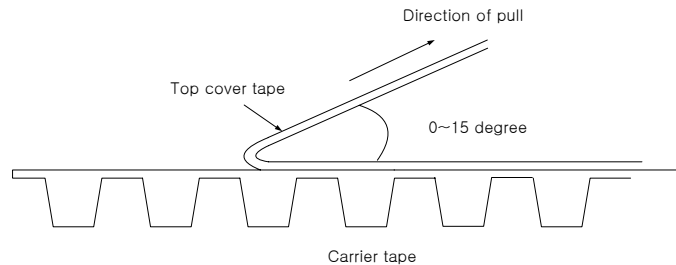

	ITF Co., Ltd. 102-901, Bucheon Technopark 364, Samjeong-Dong, Ojeong-Gu, Bucheon-City, Gyeonggi-Do, Korea 421-809	Part No.	F4521	
		Rev. Date	2006-06-08	
		Rev.	NR3016-AS02	6/7

SAW Bandpass Filter F4521



Carrier Tape Dimensions [unit : mm]

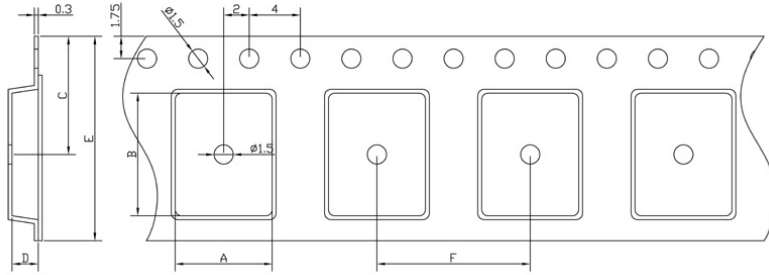

A	4.30 ± 0.1
B	4.30 ± 0.1
C	7.25 ± 0.1
D	1.70 ± 0.1
E	12.00 ± 0.1
F	8.00 ± 0.1

Part Direction

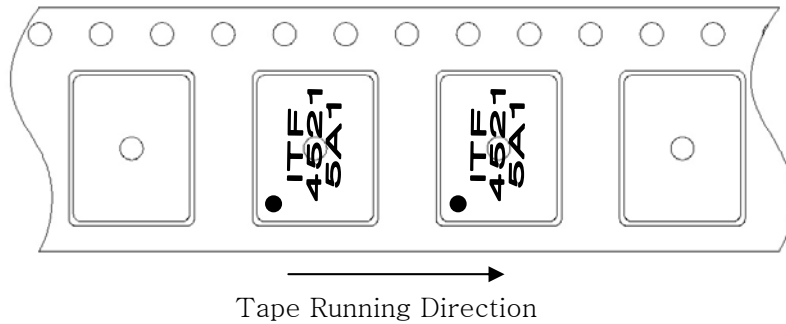

Reel Dimensions [unit : mm]

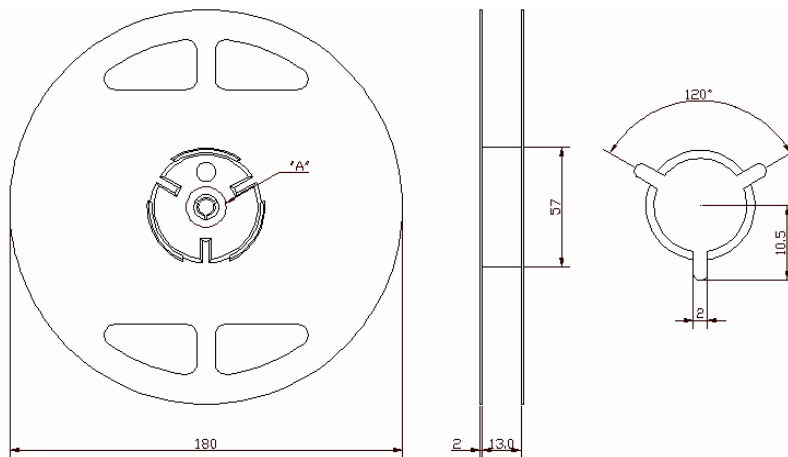

	ITF Co., Ltd. 102-901, Bucheon Technopark 364, Samjeong-Dong, Ojeong-Gu, Bucheon-City, Gyeonggi-Do, Korea 421-809	Part No.	F4521	
		Rev. Date	2006-06-08	
		Rev.	NR3016-AS02	7/7