

Bandpass Filter 250051B



1. Features

- IF bandpass filter
- Single-ended operation
- Ceramic Surface Mount Device(SMD) Package
- Maximum Storage Temperature Range : -40℃ ~ 85℃
- Electrostatics Sensitive Device (ESD)

2. Package Dimension

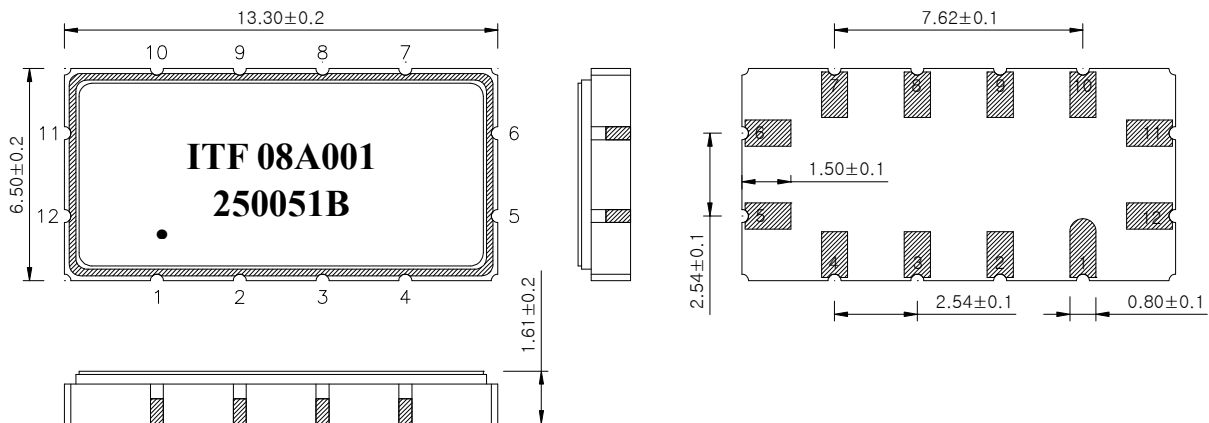

Package : S1365

Dimensions shown are nominal in millimeters

Body : Al₂O₃

Lid : Kovar, Ni Plated

Termination : Au plating 0.3 ~ 1.0um, over a 1.27 ~ 8.89um Ni Plating

Pin Configuration	
11	Input
5	Output
6, 12	Ground
Other	Case ground

	ITF Co., Ltd. 102-901, Bucheon Technopark 364, Samjeong-Dong, Ojeong-Gu, Bucheon-City, Gyeonggi-Do, Korea 421-809	Part No.	250051B	
		Rev. Date	2008-04-23	
		Rev.	NW7020-CS01	1/5

Bandpass Filter 250051B



3. Specifications

F_o = 140.0 MHz

Terminating source impedance : 50Ω and matching network

Terminating load impedance : 50Ω and matching network

Room temperature range : +25℃		Minimum	Typical	Maximum
Center Frequency (F _c)	MHz	-	140.0	-
Insertion Loss	dB	-	8.5	11.0
1dB Bandwidth	MHz	-	0.5	-
3dB Bandwidth	MHz	0.55	0.75	-
40dB Bandwidth	MHz	-	1.5	1.7
Amplitude Ripple (F _o +/- 0.12 MHz)	dB	-	0.35	1.0
Group Delay Variation (F _o +/- 0.15 MHz)	nsec	-	220	500
Absolute Delay	Usec	-	1.52	-
Relative Attenuation				
110MHz ~ F _o - 1MHz	dB	40	50	-
F _o + 1 MHz ~ 170 MHz	dB	35	40	-
Temperature Coefficient of Frequency (TCF)	ppm/℃	-	- 0.03	-

Notes :

- 1) All specifications are based on the matching schematic shown below
- 2) All specifications are measured by Agilent Network analyzer and full 2 port calibration
- 3) All attenuation measurements are measured relative to insertion loss

	ITF Co., Ltd. 102-901, Bucheon Technopark 364, Samjeong-Dong, Ojeong-Gu, Bucheon-City, Gyeonggi-Do, Korea 421-809	Part No.	250051B	
		Rev. Date	2008-04-23	
		Rev.	NW7020-CS01	2/5

Bandpass Filter 250051B



4. Matching Schematic

(Actual matching values may vary due to PCB layout and parasitics)

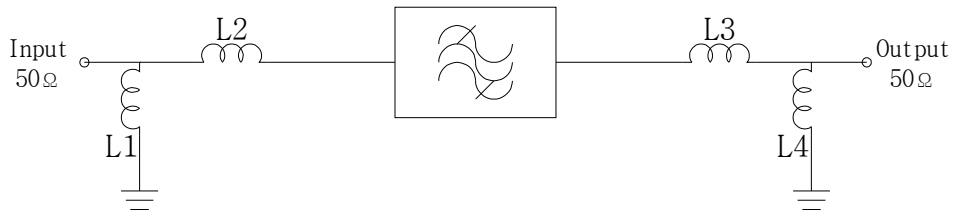

L1 = 15 nH , L2 = 33 nH

L3 = 27 nH , L4 = 18 nH

5. Marking Configuration

ITF¹⁾ 08A001²⁾

250051B³⁾

●⁴⁾

1) Manufacturer name

2) Lot Number

3) Part Number

4) Pad Number 1 Index

	ITF Co., Ltd. 102-901, Bucheon Technopark 364, Samjeong-Dong, Ojeong-Gu, Bucheon-City, Gyeonggi-Do, Korea 421-809	Part No.	250051B	
		Rev. Date	2008-04-23	
		Rev.	NW7020-CS01	3/5

Bandpass Filter 250051B



6. Typical Performance (at +25°C)

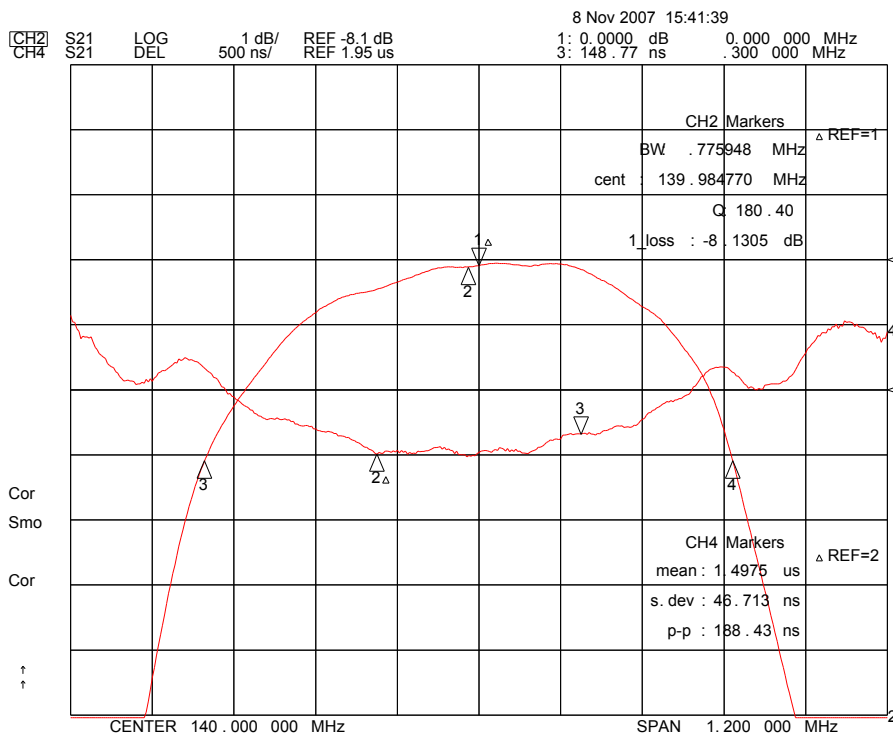
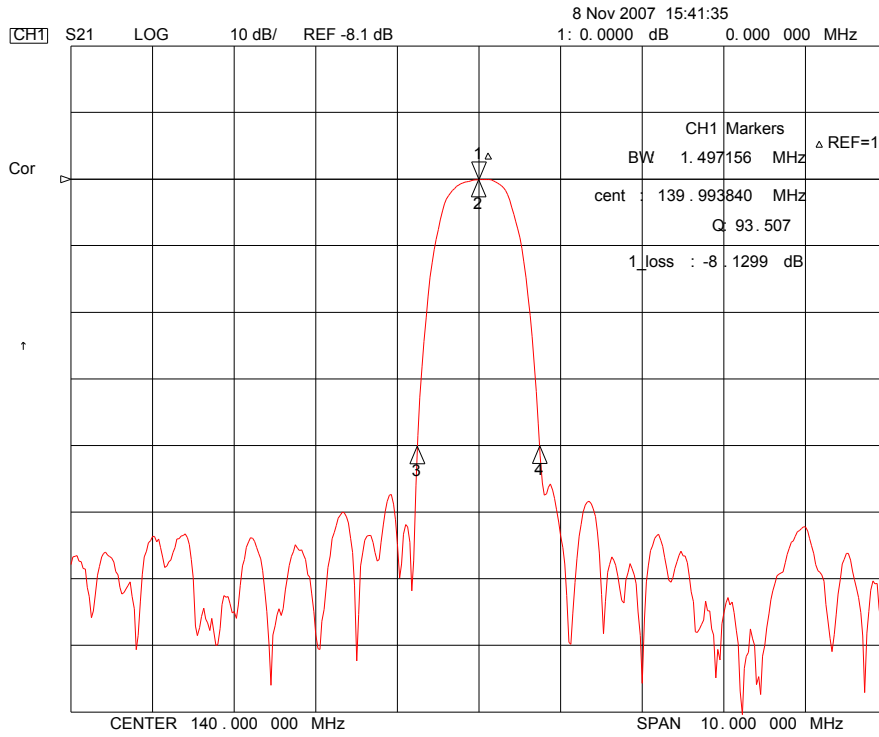

	ITF Co., Ltd. 102-901, Bucheon Technopark 364, Samjeong-Dong, Ojeong-Gu, Bucheon-City, Gyeonggi-Do, Korea 421-809	Part No.	250051B	
		Rev. Date	2008-04-23	
		Rev.	NW7020-CS01	4/5

Bandpass Filter 250051B

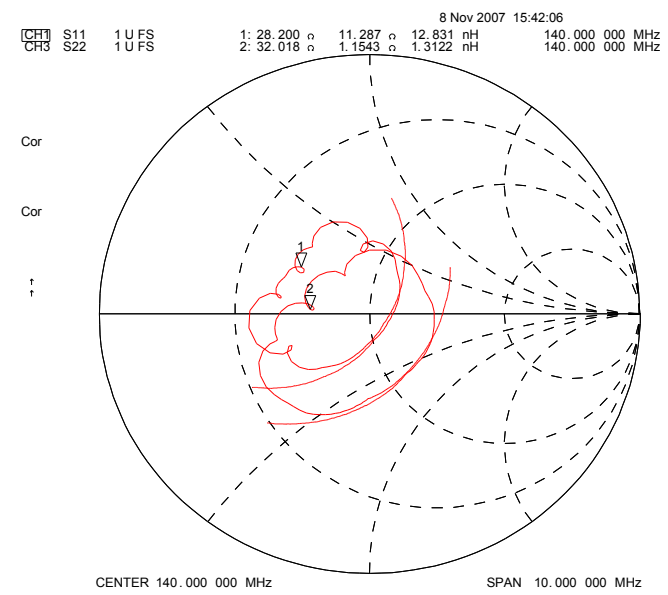
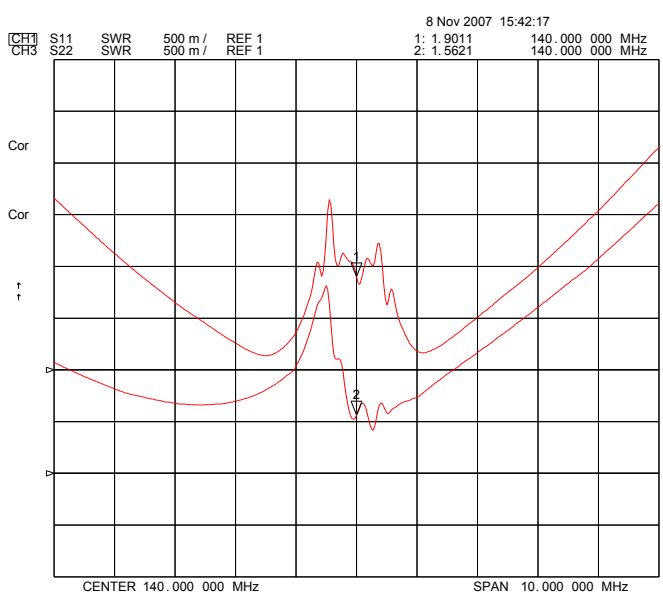
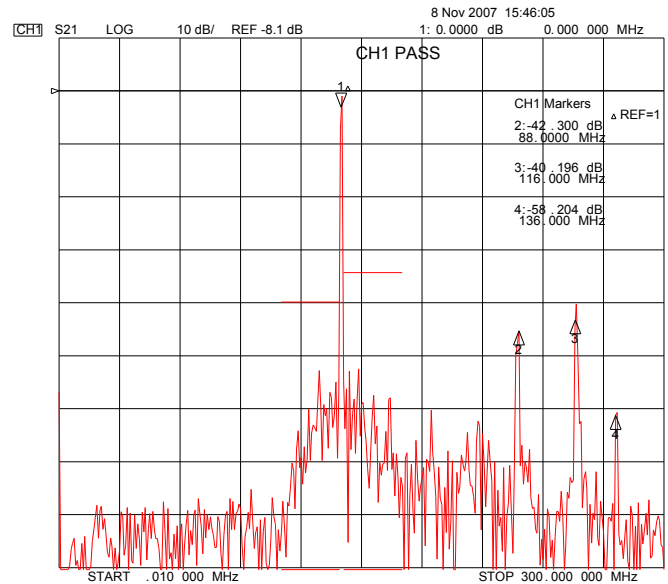
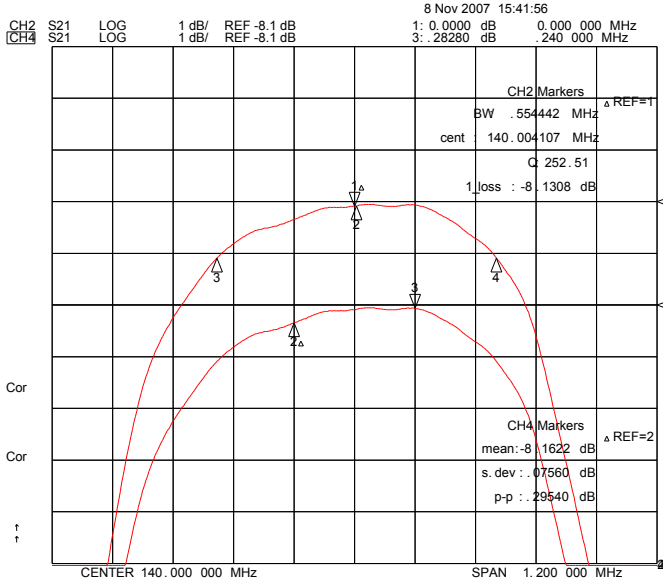

ITF Co., Ltd.
 102-901, Bucheon Technopark 364,
 Samjeong-Dong, Ojeong-Gu, Bucheon-City,
 Gyeonggi-Do, Korea 421-809

Part No.	250051B	
Rev. Date	2008-04-23	
Rev.	NW7020-CS01	5/5