

SAW Bandpass Filter 270454B



1. Features

- IF Bandpass Filter
- High Attenuation
- Single-Ended Operation
- Ceramic Surface Mount Device (SMD) Package
- Maximum Storage Temperature Range : -40 °C ~ 85 °C
- Electrostatics Sensitive Device (ESD)

2. Package Dimensions

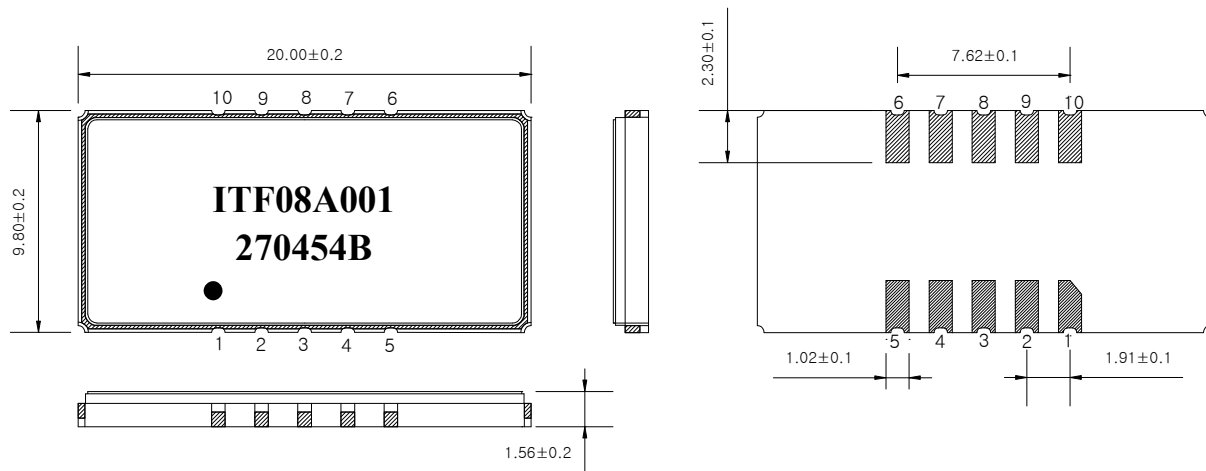

Package : S 20.0 X 9.8

Dimensions shown are nominal in millimeters

Body : Al₂O₃ Ceramic

Lid : Kovar, Ni Plated

Terminations : Au plating 0.3 ~ 1.0 um, Over a 1.27 ~ 8.89 um Ni Plating

Pad Configuration	
10	Input
5	Output
1,4	Ground
Other	Case ground



ITF Co., Ltd.
 102-901, Bucheon Technopark 364,
 Samjeong-Dong, Ojeong-Gu, Bucheon-City,
 Gyeonggi-Do, Korea 421-809

Part No.	270454B	
Rev. Date	2008-05-27	
Rev.	NM8017-CS01	1/5

SAW Bandpass Filter 270454B



3. Specifications

Fo = 70.0 MHz

Terminating source impedance : 50Ω and matching network

Terminating load impedance : 50Ω and matching network

Room Temperature : +25°C		Minimum	Typical	Maximum
Center Frequency	MHz	-	70.0	-
Insertion Loss	dB	-	22.8	24.5
1dB Bandwidth	MHz	-	4.35	-
3dB Bandwidth	MHz	4.5	4.64	-
40dB Bandwidth	MHz	-	5.84	6.0
Amplitude Ripple (fo± 1.92 MHz)	dB	-	0.4	1.0
Group Delay Variation (fo± 1.92 MHz)	Nsec	-	95	150
Absolute Delay	Usec	-	3.18	-
Ultimate Rejection	dB	50	55	-
Temperature Coefficient of Frequency	ppm/°C	-	-18	-

Notes :

- 1) All specifications are based on the matching schematic shown below
- 2) All specifications are measured by Agilent Network analyzer and full 2 port calibration at room temperature
- 3) All attenuation measurements are measured relative to insertion loss

 Integrated Technology Future	ITF Co., Ltd. 102-901, Bucheon Technopark 364, Samjeong-Dong, Ojeong-Gu, Bucheon-City, Gyeonggi-Do, Korea 421-809	Part No.	270454B	
		Rev. Date	2008-05-27	
		Rev.	NM8017-CS01	2/5

SAW Bandpass Filter 270454B



4. Matching Schematic

(Actual matching values may vary due to PCB layout and parasitics)

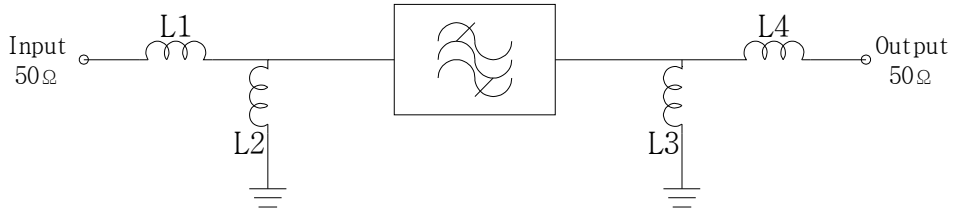

$$L1 = L2 = L3 = 220\text{nH}$$

$$L4 = 180\text{nH}$$

5. Marking Configuration

ITF¹⁾ 08A001²⁾

270454B³⁾

● ⁴⁾

1) Manufacturer name

2) Lot Number

3) Part Number

4) Pad Number 1 Index

 Integrated Technology Future	ITF Co., Ltd. 102-901, Bucheon Technopark 364, Samjeong-Dong, Ojeong-Gu, Bucheon-City, Gyeonggi-Do, Korea 421-809	Part No.	270454B	
		Rev. Date	2008-05-27	
		Rev.	NM8017-CS01	3/5

SAW Bandpass Filter 270454B



6. Typical Performance (at +25°C)

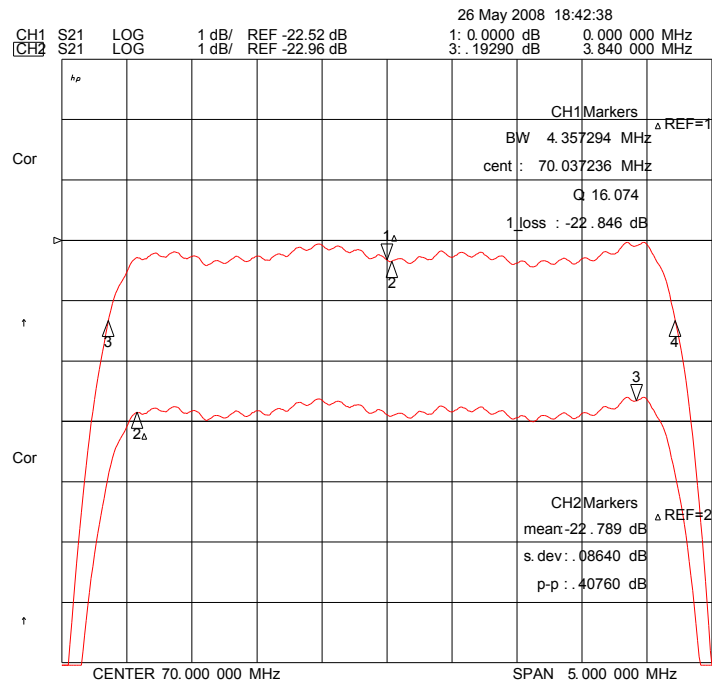
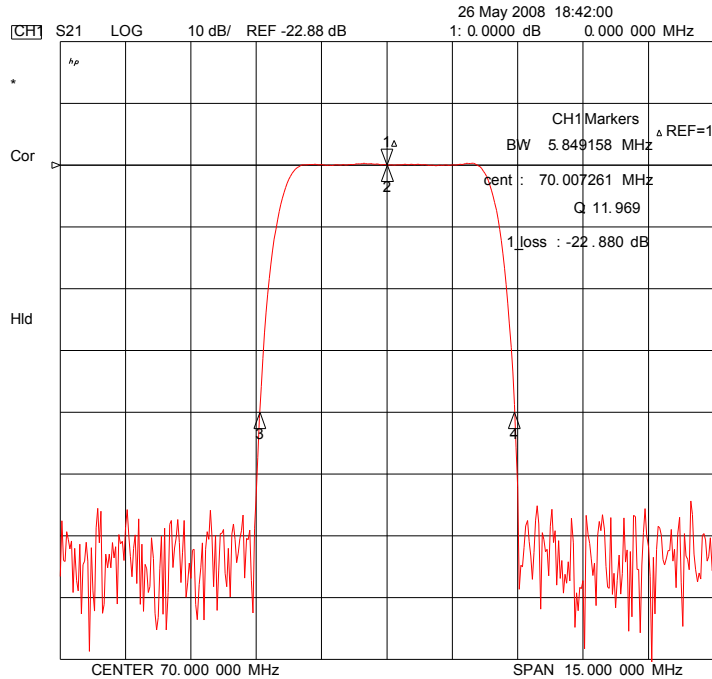

ITF Co., Ltd.
 102-901, Bucheon Technopark 364,
 Samjeong-Dong, Ojeong-Gu, Bucheon-City,
 Gyeonggi-Do, Korea 421-809

Part No.	270454B	
Rev. Date	2008-05-27	
Rev.	NM8017-CS01	4/5

SAW Bandpass Filter 270454B

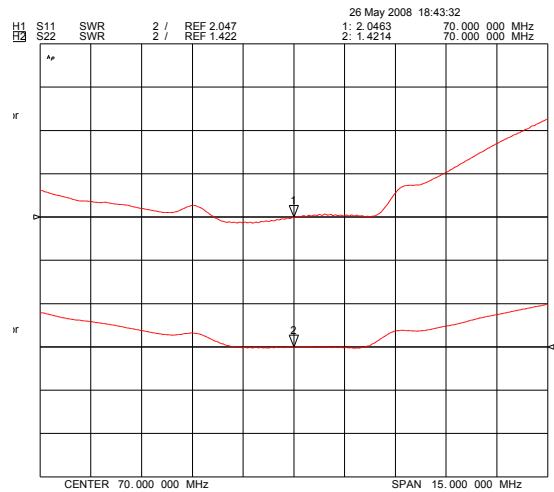
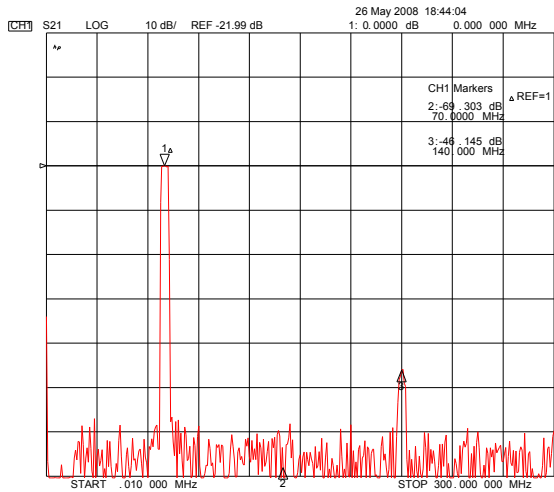
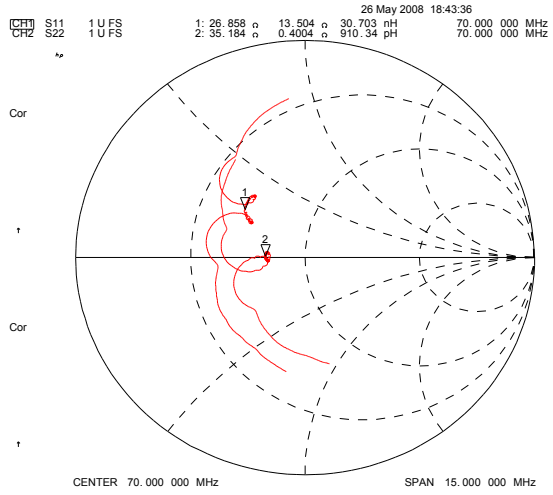
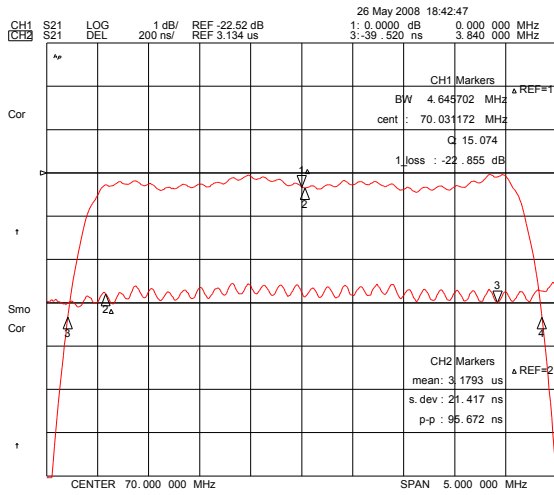

ITF Co., Ltd.
 102-901, Bucheon Technopark 364,
 Samjeong-Dong, Ojeong-Gu, Bucheon-City,
 Gyeonggi-Do, Korea 421-809

Part No.	270454B	
Rev. Date	2008-05-27	
Rev.	NM8017-CS01	5/5