

Bandpass Filter 221951B



1. Features

- IF bandpass filter
- Low-Loss Filter
- Single-ended operation
- Ceramic Surface Mount Device(SMD) Package
- Maximum Storage Temperature Range : -40℃ ~ 85℃
- Electrostatics Sensitive Device (ESD)

2. Package Dimension

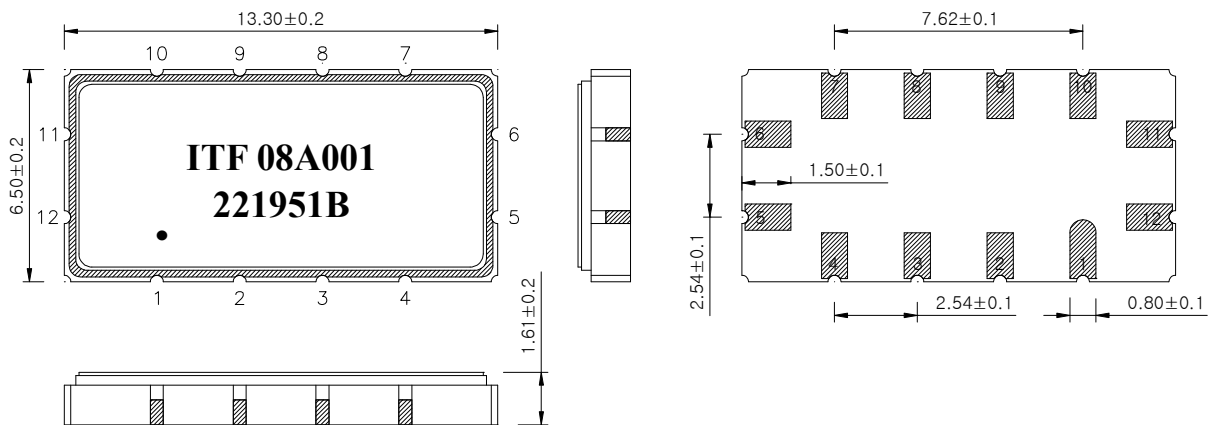

Package : S1365

Dimensions shown are nominal in millimeters

Body : Al₂O₃

Lid : Kovar, Ni Plated

Termination : Au plating 0.3 ~ 1.0um, over a 1.27 ~ 8.89um Ni Plating

Pin Configuration	
11	Input
5	Output
6, 12	Ground
Other	Case ground

	ITF Co., Ltd. 102-901, Bucheon Technopark 364, Samjeong-Dong, Ojeong-Gu, Bucheon-City, Gyeonggi-Do, Korea 421-809	Part No.	221951B	
		Rev. Date	2008-05-16	
		Rev.	NJ8009-AS01	1/5

Bandpass Filter 221951B



3. Specifications

Fo = 62.5 MHz

Terminating source impedance : 50Ω and matching network

Terminating load impedance : 50Ω and matching network

Operating temperature range : -10℃ ~ +60℃		Minimum	Typical	Maximum
Center Frequency (Fc)	MHz	-	62.5	-
Insertion Loss	dB	-	14.5	17.5
1dB Bandwidth	MHz	18.8	19.3	-
3dB Bandwidth	MHz	-	19.87	-
15dB Bandwidth	MHz	-	21.26	21.4
40dB Bandwidth	MHz	-	22.6	23.5
Amplitude Ripple (Fo +/- 9.12 MHz)	dB	-	0.4	0.9
Group Delay Variation (Fo +/- 9.12 MHz)	nsec	-	50	100
Absolute Delay	usec	-	1.25	-
Ultimate Rejection	dB	40	45	-
Temperature Coefficient of Frequency (TCF)	ppm/°C	-	- 86	-

Room temperature : + 25℃		Minimum	Typical	Maximum
Insertion Loss	dB	-	14.5	17.0
Amplitude Ripple (Fo +/- 9.32 MHz)	dB	-	0.4	0.9
Group Delay Variation (Fo +/- 9.32 MHz)	nsec	-	50	100
Relative Attenuation Fo +/- 10.2 MHz	dB	2	5	-

 Integrated Technology Future	ITF Co., Ltd. 102-901, Bucheon Technopark 364, Samjeong-Dong, Ojeong-Gu, Bucheon-City, Gyeonggi-Do, Korea 421-809	Part No.	221951B	
		Rev. Date	2008-05-16	
		Rev.	NJ8009-AS01	2/5

Bandpass Filter 221951B



Notes :

- 1) All specifications are based on the matching schematic shown below
- 2) All specifications are measured by Agilent Network analyzer and full 2 port calibration
- 3) Electrical margin has been built into the design to account for the variations due to temperature drift and manufacturing tolerances
- 4) All attenuation measurements are measured relative to insertion loss

4. Matching Schematic

(Actual matching values may vary due to PCB layout and parasitics)

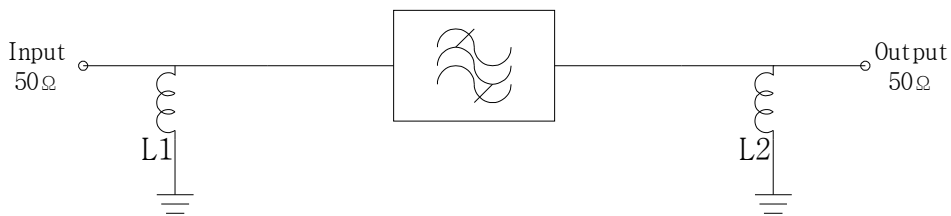

L1 = 150 nH, L2 = 82 nH

5. Marking Configuration

ITF¹⁾08A001²⁾

221951B³⁾

●⁴⁾

- 1) Manufacturer name
- 2) Lot Number
- 3) Part Number
- 4) Pad Number 1 Index

	ITF Co., Ltd. 102-901, Bucheon Technopark 364, Samjeong-Dong, Ojeong-Gu, Bucheon-City, Gyeonggi-Do, Korea 421-809	Part No.	221951B	
		Rev. Date	2008-05-16	
		Rev.	NJ8009-AS01	3/5

Bandpass Filter 221951B



6. Typical Performance (at +25°C)

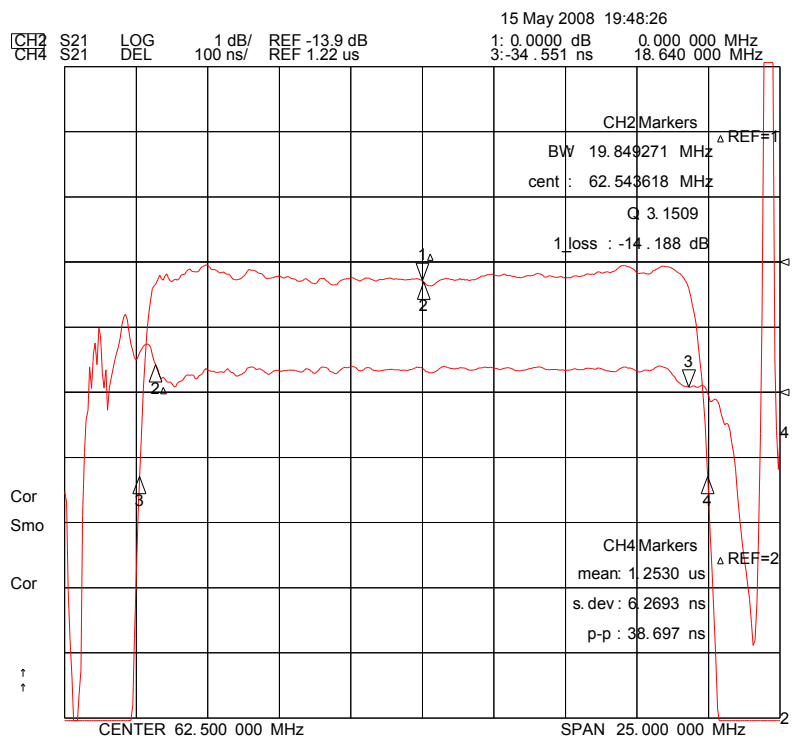
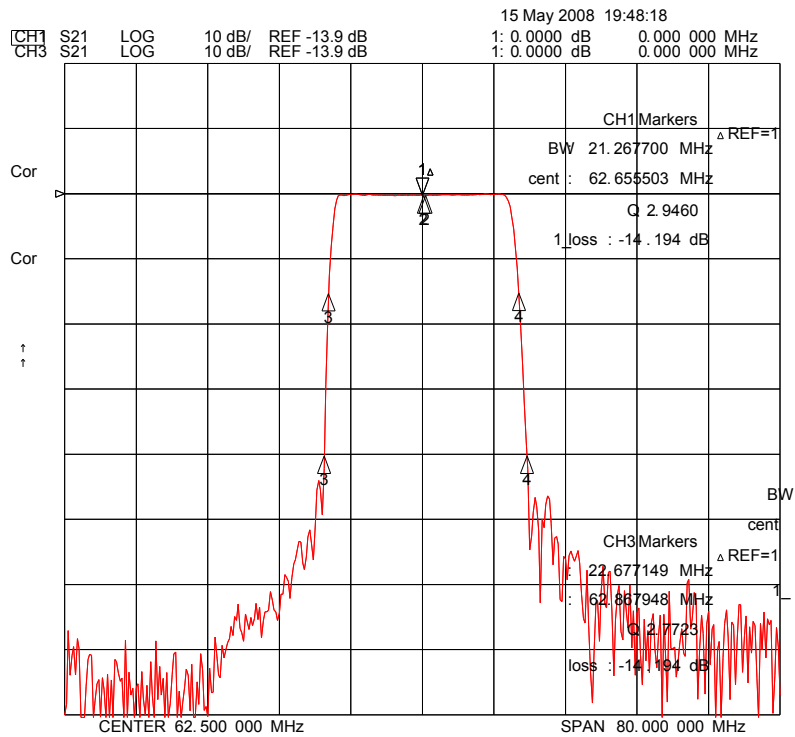

	ITF Co., Ltd. 102-901, Bucheon Technopark 364, Samjeong-Dong, Ojeong-Gu, Bucheon-City, Gyeonggi-Do, Korea 421-809	Part No.	221951B	
		Rev. Date	2008-05-16	
		Rev.	NJ8009-AS01	4/5

Bandpass Filter 221951B

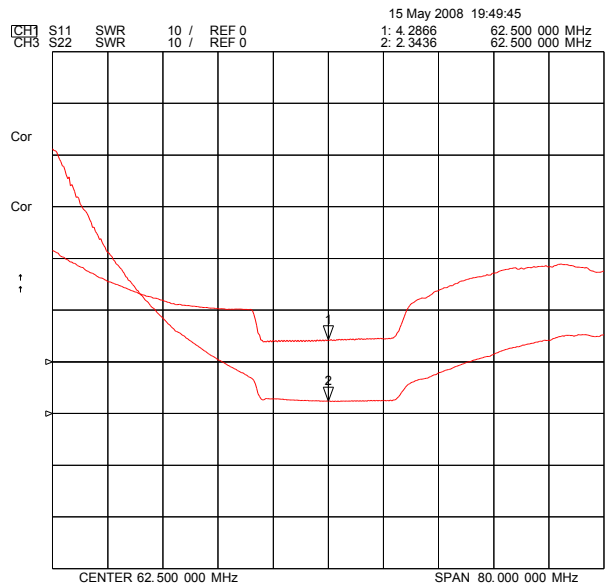
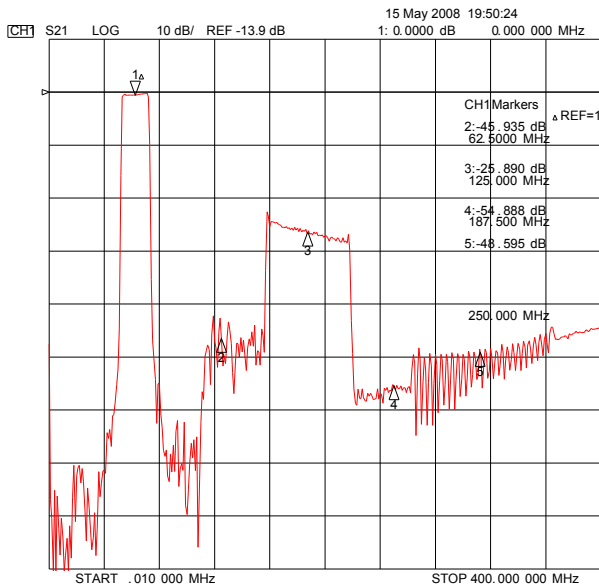
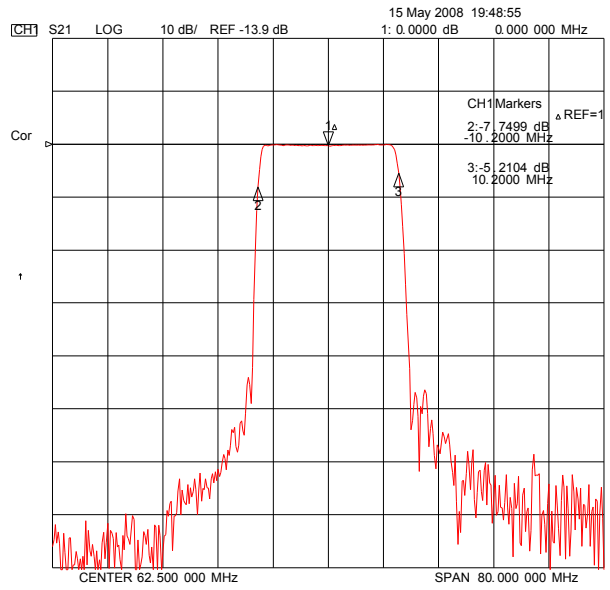
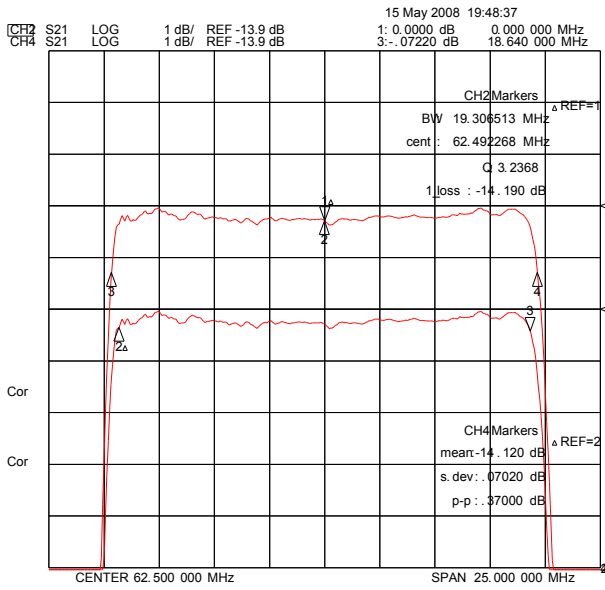

ITF Co., Ltd.
 102-901, Bucheon Technopark 364,
 Samjeong-Dong, Ojeong-Gu, Bucheon-City,
 Gyeonggi-Do, Korea 421-809

Part No.	221951B	
Rev. Date	2008-05-16	
Rev.	NJ8009-AS01	5/5