

# Bandpass Filter 210751B



## 1. Features

- IF bandpass filter
- Low-Loss Filter
- Single-ended operation
- Ceramic Surface Mount Device(SMD) Package
- Maximum Storage Temperature Range : -40°C ~ 85°C
- Electrostatics Sensitive Device (ESD)

## 2. Package Dimension

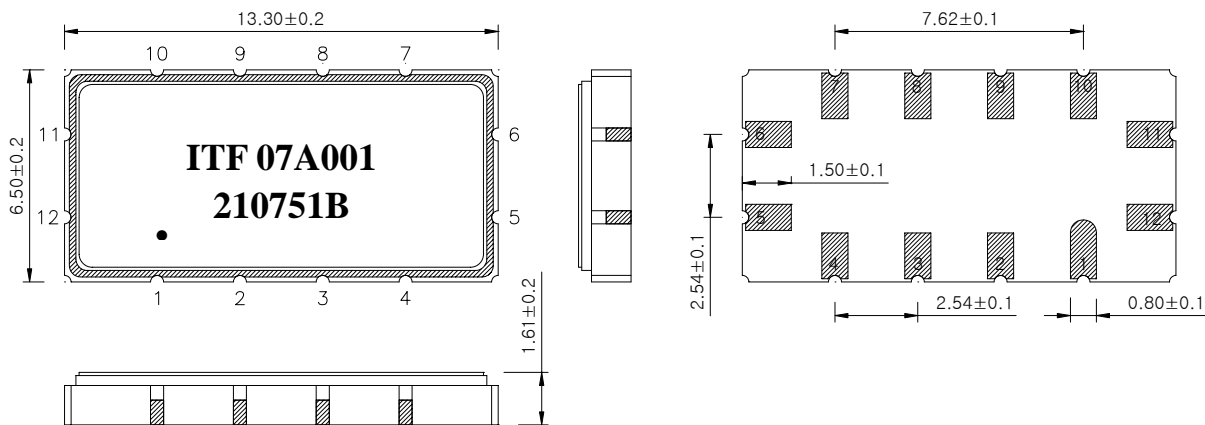

**Package : S1365**

Dimensions shown are nominal in millimeters

Body : Al<sub>2</sub>O<sub>3</sub>

Lid : Kovar, Ni Plated

Termination : Au plating 0.3 ~ 1.0um, over a 1.27 ~ 8.89um Ni Plating

Pin Configuration	
11	Input
5	Output
6, 12	Ground
Other	Case ground

	<b>ITF Co., Ltd.</b> 102-901, Bucheon Technopark 364, Samjeong-Dong, Ojeong-Gu, Bucheon-City, Gyeonggi-Do, Korea 421-809	Part No.	210751B	
		Rev. Date	2007-01-11	
		Rev.	NJ6027-CS01	1/5

# Bandpass Filter 210751B



## 3. Specifications

Fo = 60.0 MHz

Terminating source impedance : 50Ω and matching network

Terminating load impedance : 50Ω and matching network

Operating temperature range : -35℃ ~ +75℃		Minimum	Typical	Maximum
Center Frequency (Fc)	MHz	-	60.0	-
Insertion Loss	dB	-	9.5	10.5
1dB Bandwidth	MHz	6.8	7.1	-
3dB Bandwidth	MHz	7.3	7.6	-
40dB Bandwidth	MHz	-	9.7	10.2
Amplitude Ripple (Fo +/- 2.95 MHz)	dB	-	0.6	1.0
Group Delay Variation (Fo +/- 2.95 MHz)	nsec	-	80	120
Absolute Delay	usec	-	1.5	-
Ultimate Rejection	dB	40	45	-
Temperature Coefficient of Frequency (TCF)	ppm/°C	-	- 86	-

Room temperature : + 25 ℃		Minimum	Typical	Maximum
Center Frequency	MHz	-	60.0	-
Amplitude Ripple (Fo +/- 3.2 MHz)	dB	-	0.6	1.0
Group Delay Variation (Fo +/- 3.2 MHz)	nsec	-	80	120

 Integrated Technology Future	<b>ITF Co., Ltd.</b> 102-901, Bucheon Technopark 364, Samjeong-Dong, Ojeong-Gu, Bucheon-City, Gyeonggi-Do, Korea 421-809	Part No.	210751B	
		Rev. Date	2007-01-11	
		Rev.	NJ6027-CS01	2/5

# Bandpass Filter 210751B



## Notes :

- 1) All specifications are based on the matching schematic shown below
- 2) All specifications are measured by Agilent Network analyzer and full 2 port calibration
- 3) Electrical margin has been built into the design to account for the variations due to temperature drift and manufacturing tolerances
- 4) All attenuation measurements are measured relative to insertion loss

## 4. Matching Schematic

( Actual matching values may vary due to PCB layout and parasitics )

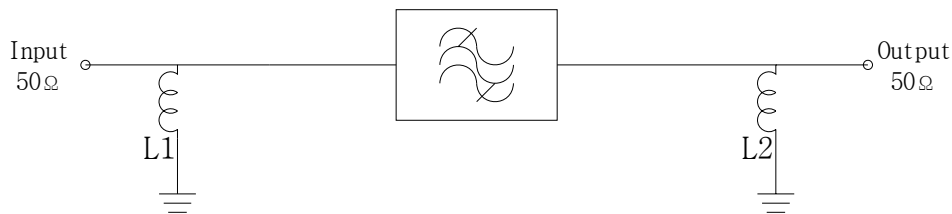

$$L1 = 68 \text{ nH}, \quad L2 = 68 \text{ nH}$$

## 5. Marking Configuration

ITF<sup>1)</sup>07A001<sup>2)</sup>

210751B<sup>3)</sup>

●<sup>4)</sup>

- 1) Manufacturer name
- 2) Lot Number
- 3) Part Number
- 4) Pad Number 1 Index

 Integrated Technology Future	<b>ITF Co., Ltd.</b> 102-901, Bucheon Technopark 364, Samjeong-Dong, Ojeong-Gu, Bucheon-City, Gyeonggi-Do, Korea 421-809	Part No.	210751B	
		Rev. Date	2007-01-11	
		Rev.	NJ6027-CS01	3/5

# Bandpass Filter 210751B



## 6. Typical Performance ( at +25°C )

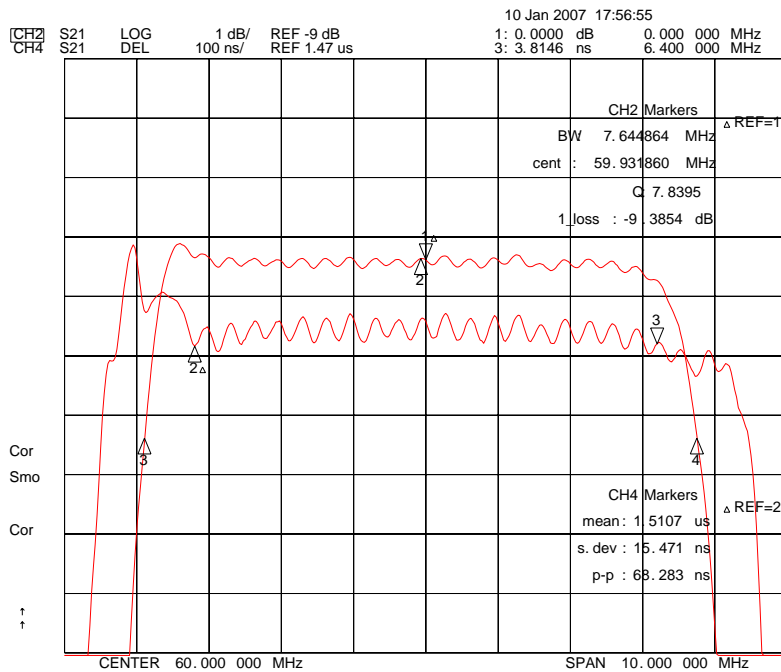
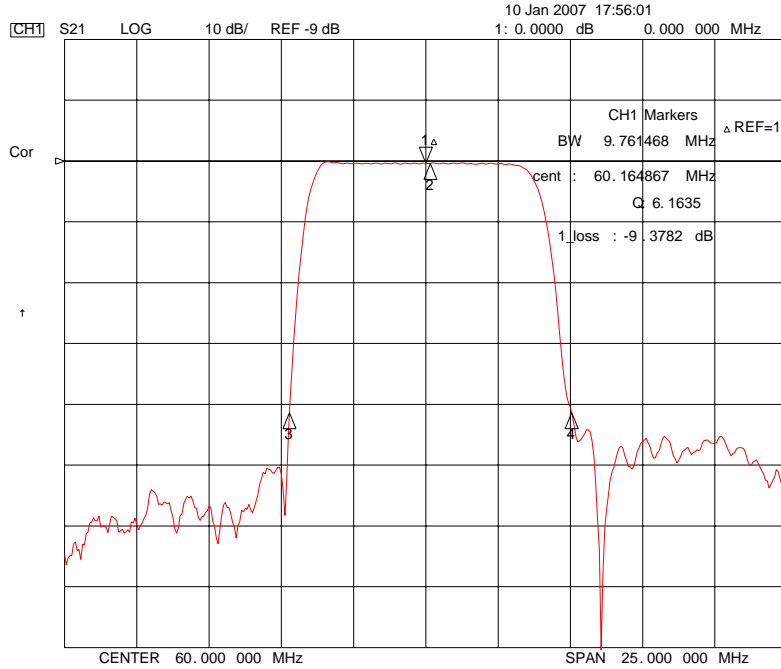

	<b>ITF Co., Ltd.</b> 102-901, Bucheon Technopark 364, Samjeong-Dong, Ojeong-Gu, Bucheon-City, Gyeonggi-Do, Korea 421-809	Part No.	210751B	
		Rev. Date	2007-01-11	
		Rev.	NJ6027-CS01	4/5

# Bandpass Filter 210751B

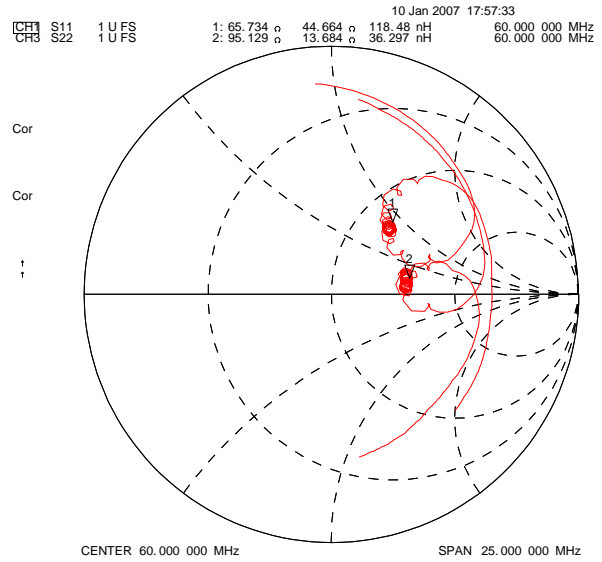
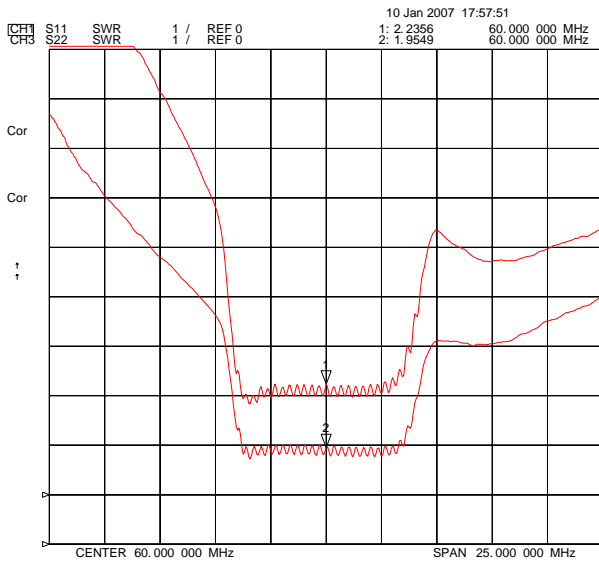
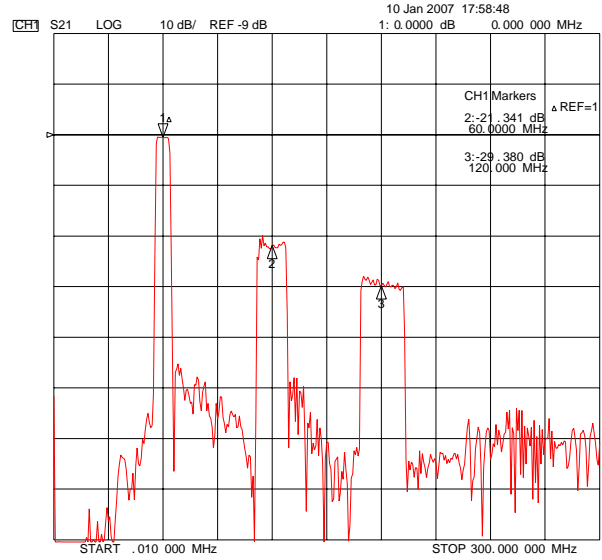
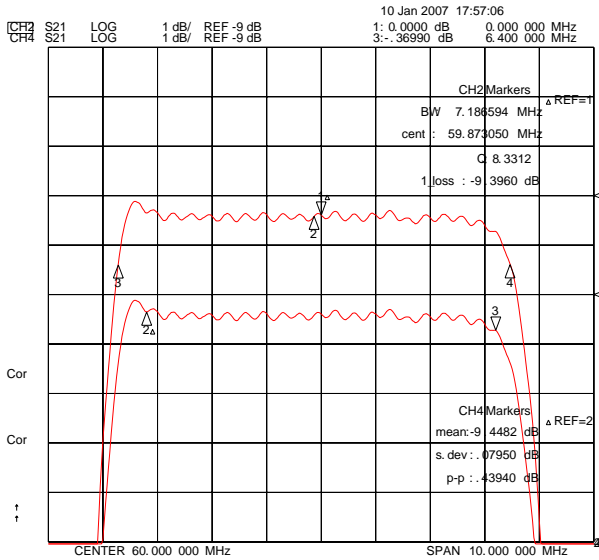

	<b>ITF Co., Ltd.</b> 102-901, Bucheon Technopark 364, Samjeong-Dong, Ojeong-Gu, Bucheon-City, Gyeonggi-Do, Korea 421-809	Part No.	210751B	
		Rev. Date	2007-01-11	
		Rev.	NJ6027-CS01	5/5