

SAW Bandpass Filter 232951B



1. Features

- IF bandpass filter
- Low-Loss Filter
- Single-ended operation
- Ceramic Surface Mount Device(SMD) Package
- Maximum Storage Temperature Range : -40°C ~ 85°C
- Electrostatics Sensitive Device (ESD)

2. Package Dimension

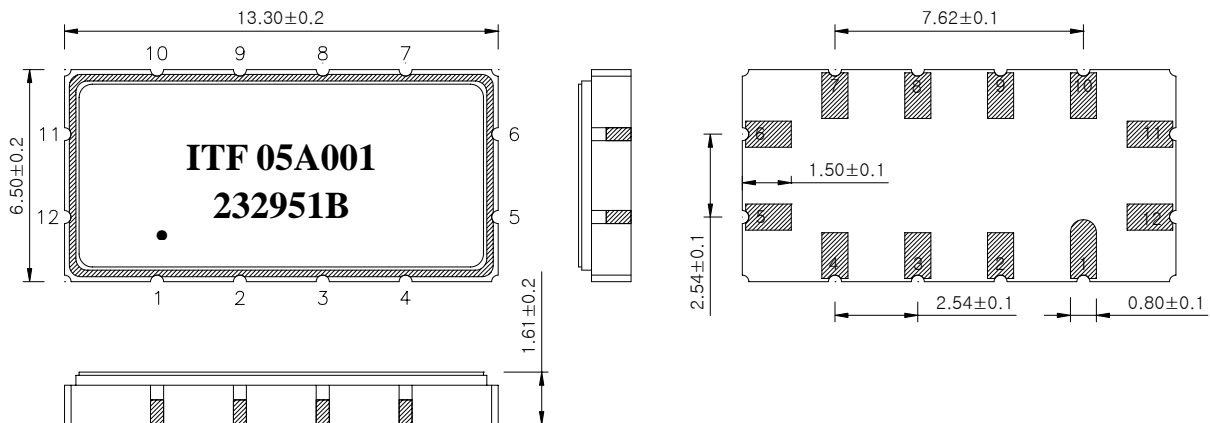

Package : S1365

Dimensions shown are nominal in millimeters

Body : Al₂O₃

Lid : Kovar, Ni Plated

Termination : Au plating 0.3 ~ 1.0um, over a 1.27 ~ 8.89um Ni Plating

Pin Configuration

11	Input
5	Output
6, 12	Ground
Other	Case ground

	ITF Co., Ltd. 102-901, Bucheon Technopark 364, Samjeong-Dong, Ojeong-Gu, Bucheon-City, Gyeonggi-Do, Korea 421-809	Part No.	232951B	
		Rev. Date	2005-11-09	
		Rev.	NJ5006-CS01	1/5

SAW Bandpass Filter 232951B



3. Specifications

Fo = 75 MHz

Terminating source impedance : 50Ω and matching network

Terminating load impedance : 50Ω and matching network

Operating temperature range : -25℃ ~ +75℃		Minimum	Typical	Maximum
Center Frequency	MHz	74.6	75.0	75.4
Insertion Loss	dB	-	21.5	24.0
1dB Bandwidth	MHz	28.0	28.6	-
3dB Bandwidth	MHz	-	29.9	-
40dB Bandwidth	MHz	-	34.8	35.5
Amplitude Ripple (Fo +/- 13.5 MHz)	dB	-	0.75	1.0
Group Delay Variation (Fo +/- 13.5 MHz)	nsec	-	25	50
Absolute Delay	usec	-	0.68	-
Relative Attenuation				
0.0 ~ 57.0 MHz	dB	40	45	
93.5 ~ 115.0 MHz	dB	35	38	-
115.0 ~ 265.0 MHz	dB	25	30	
265.0 ~ 500.0 MHz	dB	40	45	
Temperature Coefficient of Frequency	ppm/°C	-	-86	-

Room temperature : + 25℃		Minimum	Typical	Maximum
Center Frequency	MHz	74.9	75.0	75.1
Insertion Loss	dB		21.5	23.5
Amplitude Ripple (Fo +/- 13.75 MHz)	dB	-	0.75	1.0
Group Delay Variation (Fo +/- 13.75 MHz)	nsec	-	25	50

 Integrated Technology Future	ITF Co., Ltd. 102-901, Bucheon Technopark 364, Samjeong-Dong, Ojeong-Gu, Bucheon-City, Gyeonggi-Do, Korea 421-809	Part No.	232951B	
		Rev. Date	2005-11-09	
		Rev.	NJ5006-CS01	2/5

SAW Bandpass Filter 232951B



Notes :

- 1) All specifications are based on the matching schematic shown below
- 2) All specifications are measured by Agilent Network analyzer and full 2 port calibration
- 3) Electrical margin has been built into the design to account for the variations due to temperature drift and manufacturing tolerances
- 4) All attenuation measurements are measured relative to insertion loss

4. Matching Schematic

(Actual matching values may vary due to PCB layout and parasitics)

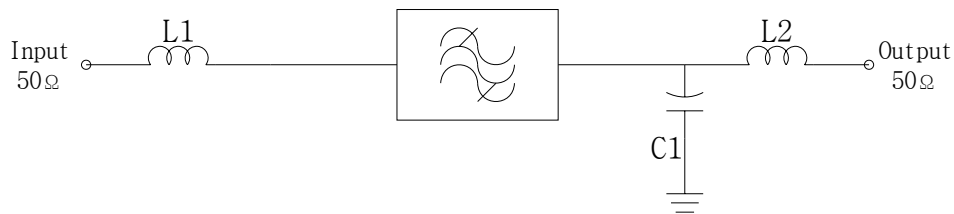

L1 = 120 nH, L2 = 120 nH

C1 = 18 pF

5. Marking Configuration

ITF¹⁾ 05A001²⁾

232951B³⁾

● 4)

- 1) Manufacturer name
- 2) Lot Number
- 3) Part Number
- 4) Pad Number 1 Index

	ITF Co., Ltd. 102-901, Bucheon Technopark 364, Samjeong-Dong, Ojeong-Gu, Bucheon-City, Gyeonggi-Do, Korea 421-809	Part No.	232951B	
		Rev. Date	2005-11-09	
		Rev.	NJ5006-CS01	3/5

SAW Bandpass Filter 232951B



6. Typical Performance (at +25°C)

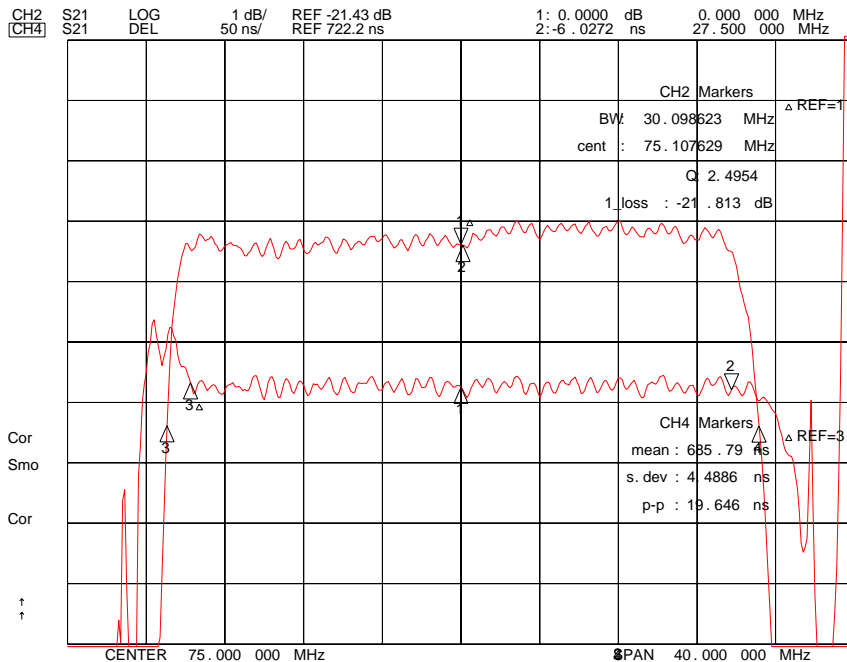
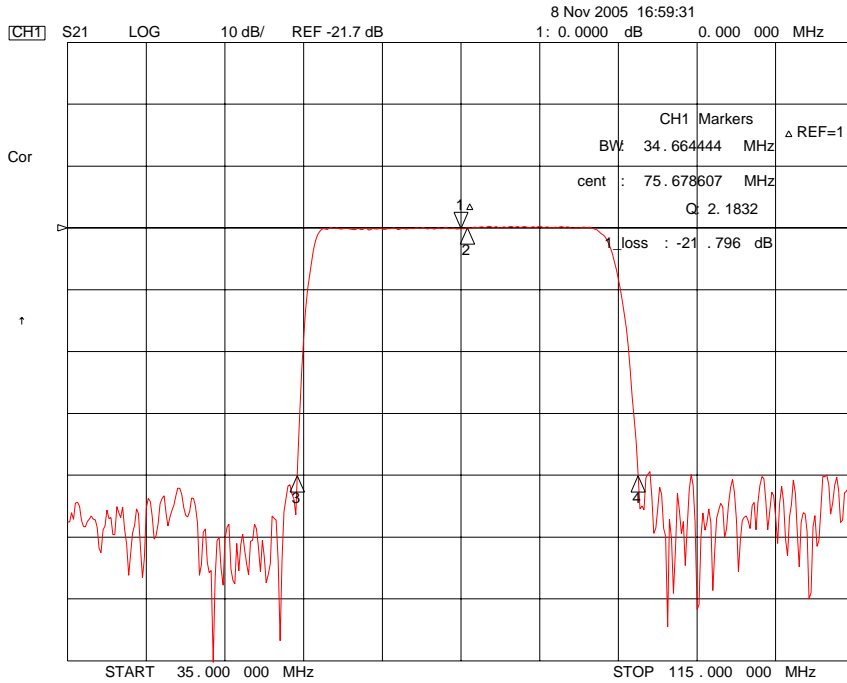

	ITF Co., Ltd. 102-901, Bucheon Technopark 364, Samjeong-Dong, Ojeong-Gu, Bucheon-City, Gyeonggi-Do, Korea 421-809	Part No.	232951B	
		Rev. Date	2005-11-09	
		Rev.	NJ5006-CS01	4/5

SAW Bandpass Filter 232951B

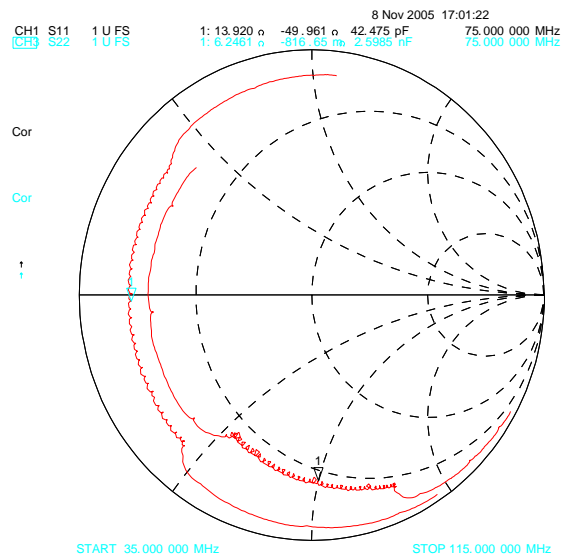
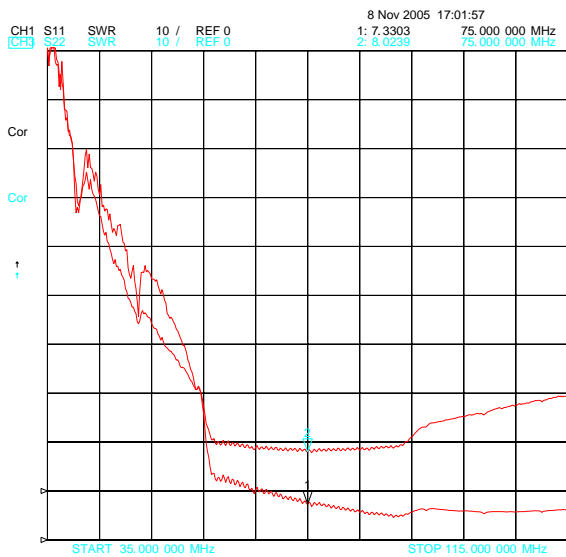
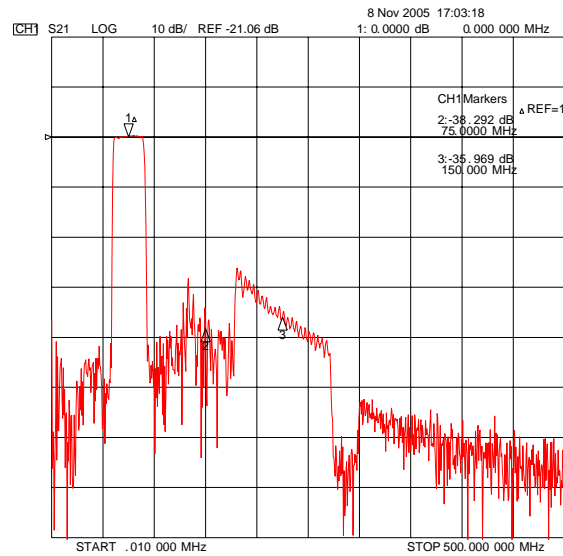
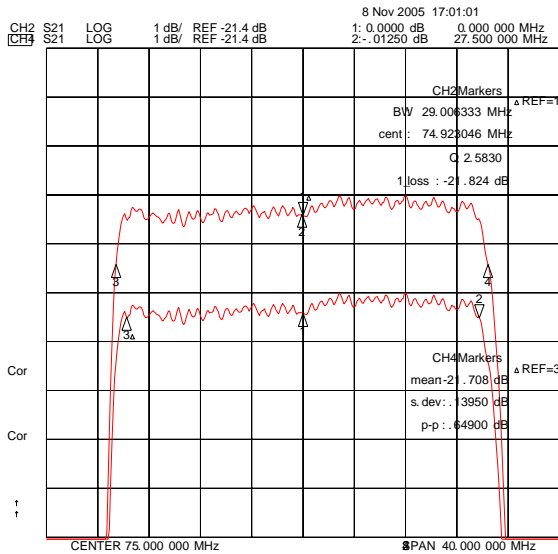

ITF Co., Ltd.
 102-901, Bucheon Technopark 364,
 Samjeong-Dong, Ojeong-Gu, Bucheon-City,
 Gyeonggi-Do, Korea 421-809

Part No.	232951B	
Rev. Date	2005-11-09	
Rev.	NJ5006-CS01	5/5